

Orthopedic

IMPLANTS & INSTRUMENTS

Spine INSTRUMENTS

New
Edition







SMART SMYTH

Manufacturers & Exporters



 : Gala Capricorn Wala,
Sialkot Road, Daska Sialkot Pakistan.

 : 0092 302 6617169
 : uzair.mughal98@gmail.com
 : info@smartsmythintl.com
 : www.smartsmythintl.com

3.5mm Screws

Bone Screws



050-001
Cortical Srew
1.5mm
Ranges :
6 20mm



050-002
Cortical Srew
2.0mm
Ranges :
6 38mm



050-003
Cortical Srew
2.7mm
Ranges :6 40mm



050-004
Cortical Srew
3.5mm
Ranges 8 60mm,
1.75mm Thread



050-005
Cortical Srew
3.5mm
Ranges 10 60mm,
1.25mm Thread



050-006
Cortical Srew
4.0mm
Ranges 10 60mm
Full Thread



050-007
Cortical Srew
4.0mm Ranges
10 60mm
Short Thread

Large Screws with Spherical Head and Hexagonal Socket



050-008
Cortical Shaft Srew
4.5mm
Ranges: 12 110mm



050-009
Cortical Srew
4.5mm
Ranges: 12 110mm



050-010
Malleolar Srew
4.5 mm
Ranges 25 70mm ,



050-011
Cancellous Srew
6.5 mm
Ranges "30 120mm ,
16mm Thread



050-012
Malleolar Srew
6.5 mm
Ranges "30 120mm
,32mm Thread



050-013
Malleolar Srew
6.5 mm
Ranges "30 120mm ,
Full Thread



050-014
Malleolar Flat Head Srews
6.5 mm
Ranges "30 120mm ,
16, 32 & Full Thread



050-015
Emergency Srews Self Tap
4.5 mm
Ranges : 12 80mm



050-016
Titanium Sancellous
Srew
6.5 mm
Ranges :
40 50 mm



050-017
Sherman Srew
4.0mm
Ranges:
10 40 mm

Cannulated Screws



050-018
Cannulated Screw
3.0mm x 1.0mm
Ranges :8mm 40mm
Thread Length 6mm



050-019
Cannulated Screw
34.5/3.0mm x 1.75mm
Ranges :10 x 110mm,
Fully Threaded



050-020
Cannulated Screw
4.5/3.0mm x 1.75mm
Ranges :14-110mm
Thread 7-32mm



050-021
Cannulated Screw
3.5/2.4mm x 125mm
Ranges :
10mm 60mm Fully Threaded



050-022
Cannulated Screw
3.5/2.4mm X 1.25mm
Ranges:
10 - 60mm
Threaded 1/3
of the Length



050-023
Cannulated Screw
6.5/4.0mm x 1.75mm
Ranges:
12 -80mm
Fully Threaded



050-024
Cannulated Screw
4.0-2.5mm x 1.75mm
Ranges:
10 -75mm ,
Thread 1/3of the length



050-025
Cannulated Screw
4.5/3.0mm x 1.75mm
Ranges: 14 -110mm
Fully Threaded



050-026
Cannulated Screw
4.5-3.0mm x 1.75mm
Rangs :
14 - 110mm ;
Thread 7-32



050-027
Cannulated Screw
5.0/3.5mm x
1.75mm
Ranges: 12 -80 mm,
Thread 7-20mm



050-028
Cannulated Screw
5.0/3.5mm x 1.75mm
Ranges: 12 -80 mm,
Full Thread



050-029
Cannulated Screw
6.5/4.0mm x 2.75mm
Ranges:30 -130mm
Thread 16mm



050-030
Cannulated Screw
7.0/4.0mm x 2.75mm
Ranges:30 -130mm
Thread 16mm



050-031
Cannulated Screw
7.0/5.0mm x 1.75mm
Ranges:35 -130mm
Thread 20mm



050-032
Cannulated Screw
7.0/5.0mm x 1.75mm
Ranges:35 -130mm
Thread 22-32mm



050-033
Cannulated Screw
7.0/5.0mm x 1.75mm
Ranges:35 -130mm
Fully Thread

050-034
Semi Tubular Plate
Ranges :2 - 12 hole



050-035
Narrow Bone Plate
Ranges :2 - 16 hole



050-036
Broad Bone Plate
Ranges :4 - 24 hole

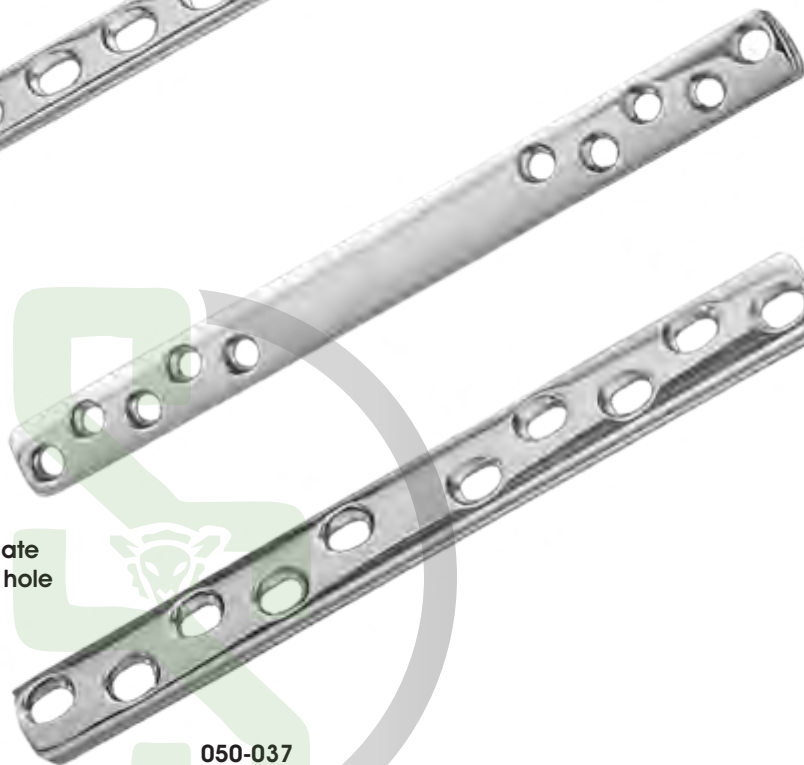

050-037
Bord Lengthening Plate
Ranges :50 - 120mm

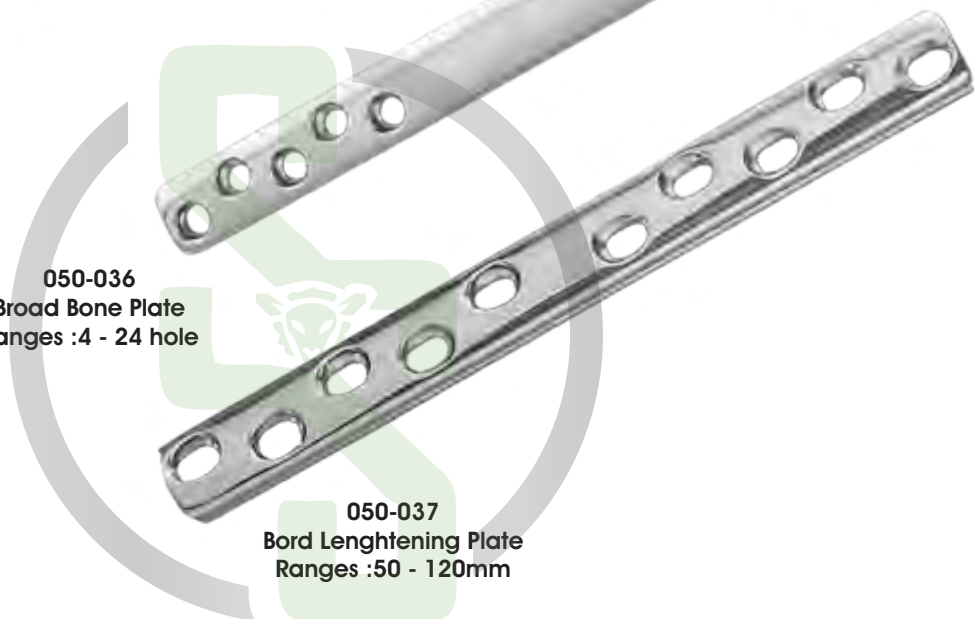

050-038
Narrow Lengthening Plate
Ranges :30 - 80mm

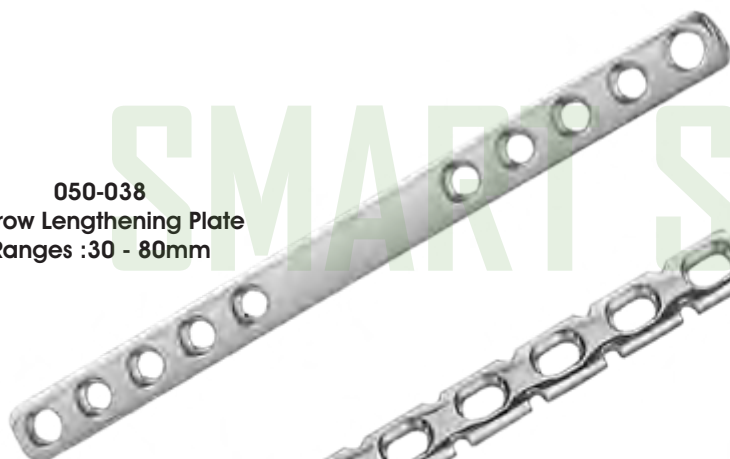

050-039
Re-Costruction Plate
Ranges :3 - 16 hole



Special Plates

050-040
Distal Tibia Plate, Ranges:7-13 hole
(Left+Right)



050-041
Proximal Tibia Plate
Ranges: 7-13 hole
(left+Right)



SPECIAL Plates



050-042
Spoon Plate
Ranges :5-6 & 12 hole

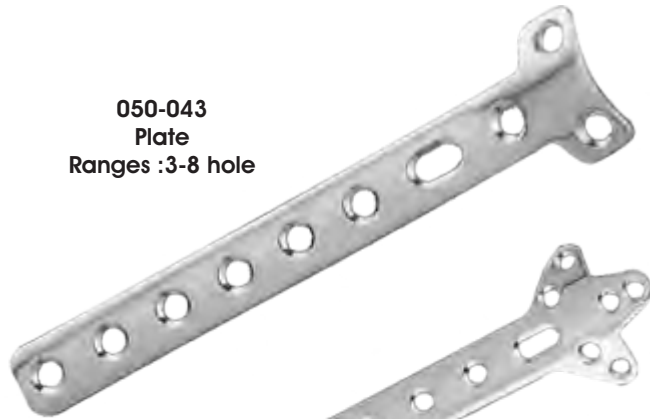

050-043
Plate
Ranges :3-8 hole



050-044
Cloverleaf Plate
Ranges :3 & 4 hole



050-045
T-Buttress Plate
Ranges :4 - 6 hole



050-046
Ranges :4 hole
(Left + Right)



050-047
T Plate
Ranges :3-8 hole

Mini Frarment Plate For 2.7 mm Screws



050-048
L Buttress Plate
Range:4 hole
(Left + Right)



050-049
Fingrer Joint - Head Plate
Ranges :L Plate,Oblique
(L + R)



T Plate
as Long Standard

050-050
Lateral Tibial Head
Butterss Plate
Ranges : Shaft With
5-9 hole(Left + Right)

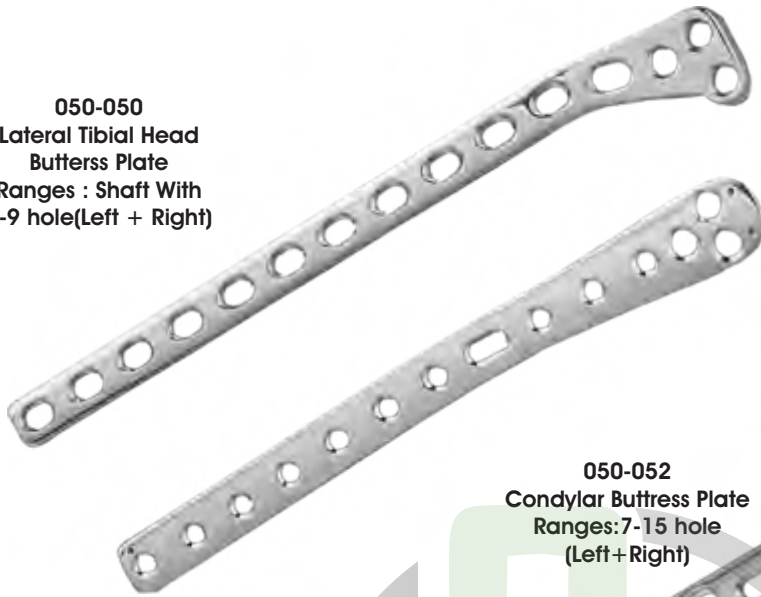

050-052
Condylar Buttress Plate
Ranges:7-15 hole
(Left+Right)

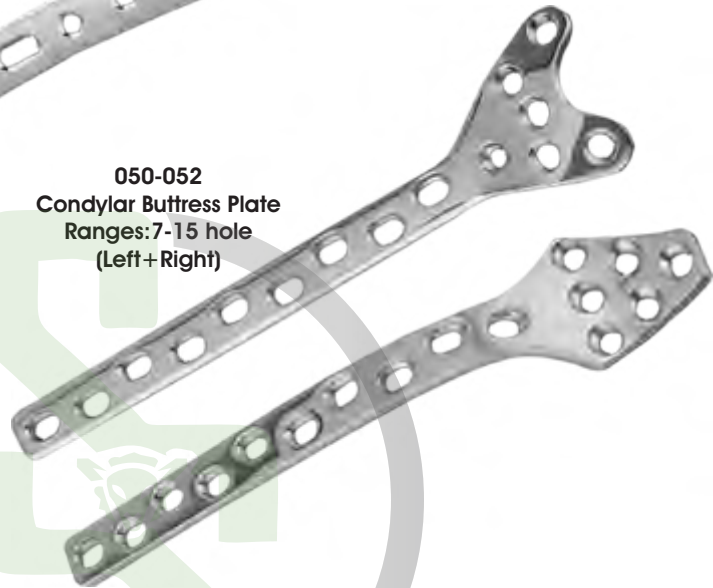

050-051
Distal Femur Plate
Ranges :7 - 13 hole
(Left + Right)

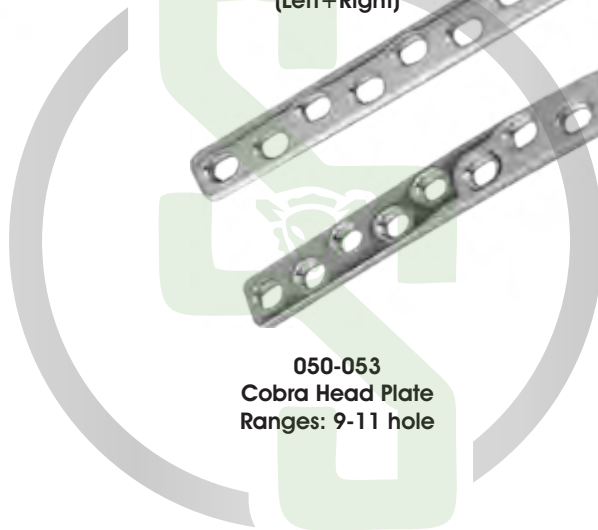

050-053
Cobra Head Plate
Ranges: 9-11 hole



050-054
Small T Plate (Rigly Angle)
For Distal radius
Ranges :3 - 6 hole Shaft / Head



050-055
For Humeral Condyle



050-056
Small Tplate (oblique Angle)
For Distal Radius
Ranges :3- 5 hole on Shaft
3 on Head



050-057
Pelvis 3.5
Reconstruction Plate
Ranges:6 - 18 holes

ORTHOPEDIC STRAIGHT PLATES

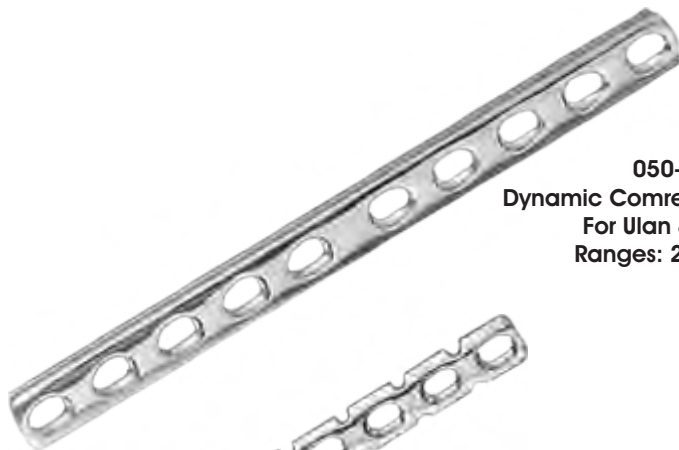

050-058
Dynamic Compression Plate DCP
For Ulna & Radius
Ranges: 2- 12 hole



050-059



050-060
Small Adaptation Plate
Ranges :20 Hole



050-061
Reconstruction Plate 27
Ranges:5 - 24 hole



050-062
Adaptation Plate
Ranges :20 hole



050-063



050-064



050-065
Dynamic Compression Plate
DCP
Ranges :2-12 hole



050-066
Straight mini Plate
Ranges :3-20 hole



050-067
Mandibular Plate
Ranges :5-6 hole

Mini Fragment Plate For 2.0 mm Screws



050-068
Y Plate
Ranges: One size



050-069
DHS Trochanter Plate
Ranges: 138mm &
147 mm Length



050-070
Tibial Plate (L+R)
Ranges: 3 6 hole



050-071
Sherman Bone Plate
Ranges : 2 10 hole

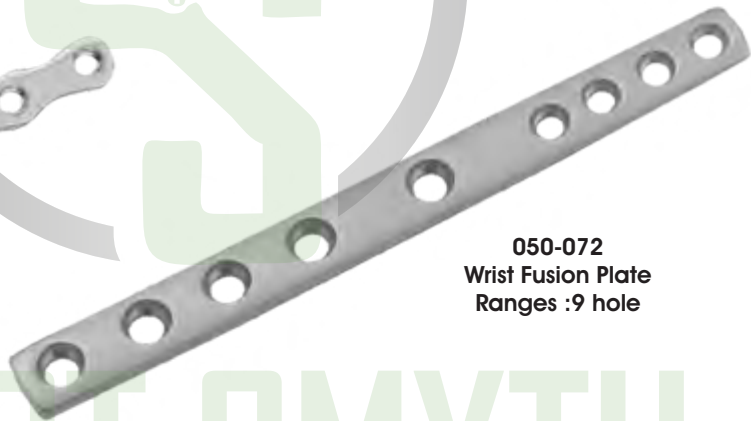

050-072
Wrist Fusion Plate
Ranges : 9 hole



050-073
Lockig Compression Plate
Range : 2 16 hole



050-074
LC-DCP 4.5, Na Plate
Ranges : 4 12 hole

SMART SMYTH

DHA/DCS IMPLANTS



050-075
DHS/DCS
Compression Screws 36mm Length

050-076
DHS/DCS
Compression Screws
36mm Length

050-077
DHS Plate
135°, 140°, 145° & 150°
Ranges: 2 - 12 hole
Barrel Length 25mm & 38mm

050-078
DCS Plate 95°
Ranges: 6 - 16 hole

050-079
Jewet Nail Plate 135°
Ranges: 4-16 hole
& 50 - 120mm Blade

050-080
Special Jewet Nail Plate 130°
Ranges: 4-16 hole
& 50 - 120mm Blade

Special Plates

050-081
Condylar Plate 95°
Ranges : 3 - 10 hole
& blade length 50 - 80mm

050-082
Marquardt Bone Plate
(for kids)
Ranges : 3 hole

050-083
Angled Blade Plate 130°
Ranges: 3 - 10 hole
& blade length 50- 110mm

050-084
Angled Blade Plate for
Intertrochanteric Femur Osteomy
Ranges: 110°, 120°, 130°
4 hole blade length 65-110mm

SPINE FIXATION



050-085
Caper Trapezial Plates
for Cervical Spine
For Screw 3.5 mm



050-087
Zplate for Cervical Spine
Ranges :35 -50 mm



050-086
Casper Plate Titanium
for Cervical Fixation
Ranges :4 to 10 hole



050-088
Spinal Cage Non Adjustable
26 mm dia
Ranges: 25-70mm Length

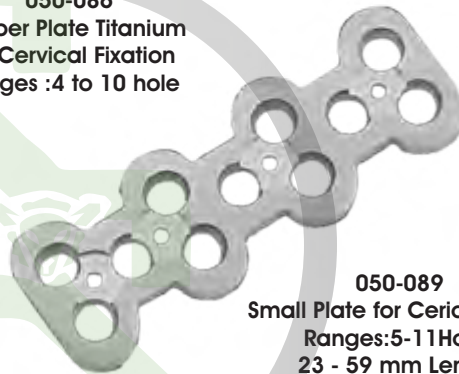

050-089
Small Plate for Cervical Spine
Ranges:5-11Holes
23 - 59 mm Length

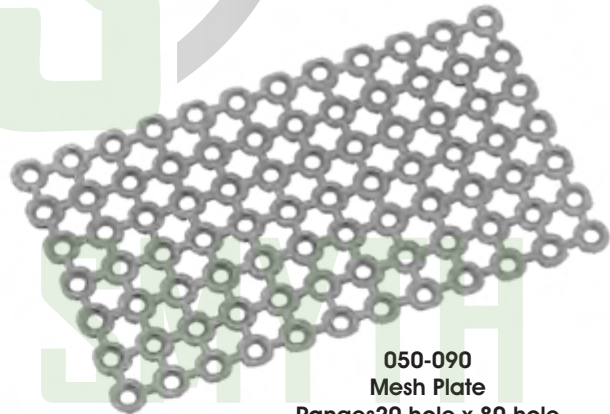

050-090
Mesh Plate
Ranges20 hole x 80 hole

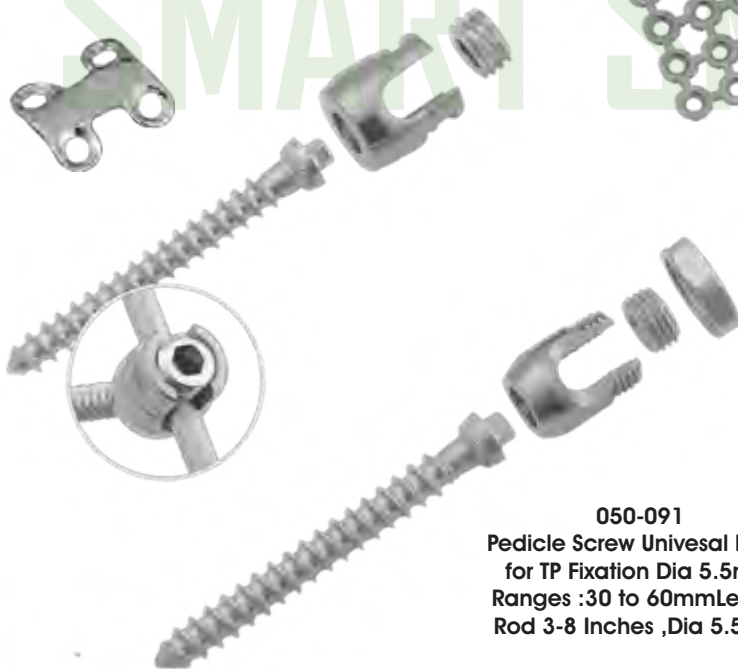

050-091
Pedicle Screw Univesal Head
for TP Fixation Dia 5.5mm
Ranges :30 to 60mmLength
Rod 3-8 Inches ,Dia 5.5mm



NEWLY ADDED

AUSTIN MOORE
HIPPROSTHESIS
(STANDARD, NARROW)



050-92
Ranges:38MM TO 58MM

THOMPSON
HIPPROSTHESIS
(STANDARD)



050-93
Ranges:38MM TO 58MM

BIPOLAR
HIPPROSTHESIS
(STANDARD)



050-94
Ranges:38MM TO 58MM

SMART SMYTH

LOCKING SCREW 3.5 MM



050-95
Ranges:12MM TO 80MM

LOCKING SCREW 4.0 MM



050-96
Ranges:12MM TO 80MM

LOCKING SCREW 5.0 MM



050-97
Ranges:12MM TO 50MM

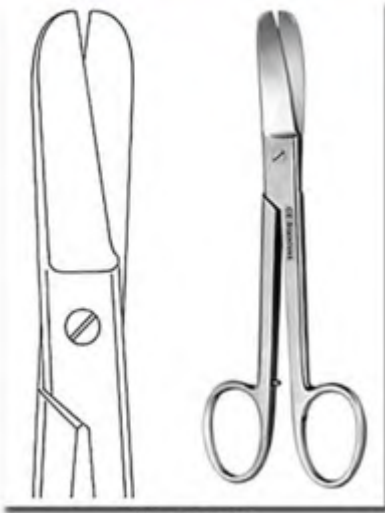

051-101
Lorenz Bandage Scissors
Heavy Pattern (23 cm / 9")



051-102
Lister Bandage Scissors
14.5 cm / 5 3/4"

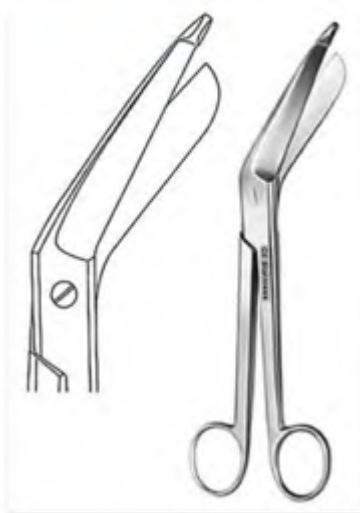

051-103
Bergmann Plaster Shears
Heavy Pattern
23.5 cm / 9 1/4"



051-104
Esmarch Plaster Shears
Heavy Pattern, Short Blades
20 cm / 8"



051-105
Bandage Scissors
16 cm / 6 1/4"
Black Plastic Rings



051-106
Bruns Plaster Scissors
24 cm / 9 1/2"
One Serrated Cutting Edge



051-107
Stille-Martin
Plaster Shears
A: 23 cm / 9"
B: 26 cm / 10"
C: 38 cm / 15"



051-108
Engel Plaster Saw 15.5 cm / 6"



051-109
Hopkins Plaster Knife
20 cm / 8"
with Wooden Handle



051-110
Esmarch
Plaster Knife
18 cm / 7"



051-111
Reiner
Plaster Knife
18 cm / 7"



051-112
Martin
Plaster Knife
21 cm / 8 1/4"



051-113
Engel Plaster Saw 15.5 cm / 6"

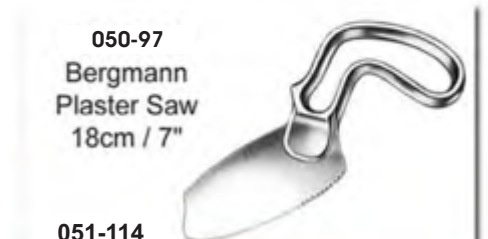

050-97
Bergmann
Plaster Saw
18cm / 7"

051-114

PLASTER CAST INSTRUMENTS



051-115
Hermann Plaster Spreader
48 cm / 19" Heavy Pattern



051-116
Hennig Plaster Spreader
28 cm / 11"



051-117
Hennig
Plaster Spreader
30 cm / 12"



051-118
Beeson Plaster Spreader
1.5 In Blade
30 cm / 12"



051-119
Walton Plaster Spreader
w/Spring 3 Prongs
23 cm / 9"

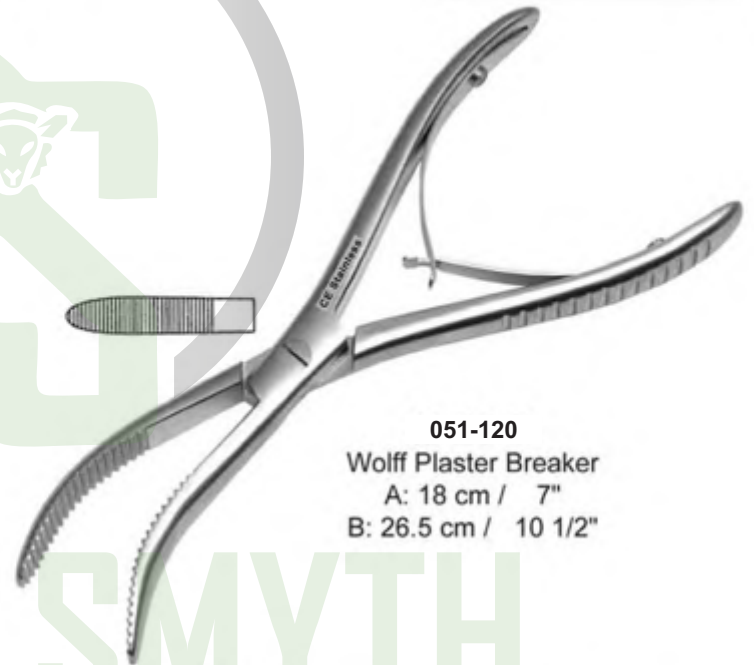

051-120
Wolff Plaster Breaker
A: 18 cm / 7"
B: 26.5 cm / 10 1/2"



Also Available
in Non TC
Version

051-121 -TC
Lister
Bandage Scissors
TC / Handle gold
18 cm / 7"



**TC
GOLD**



051-122 -TC
Bruns
Plaster Scissors
24 cm / 9 1/2"
Also Available
in Non TC
Version



AMPUTATION SAWS - GIGLI SAW



051-123 Charrière Amputation Saw
35 cm / 13 3/4"

- 21.5 cm / 8 3/4" 12mm wide Spare Saw Blades
- 21.5 cm / 8 3/4" 15mm wide Spare Saw Blades
- 21.5 cm / 8 3/4" 18mm wide Spare Saw Blades

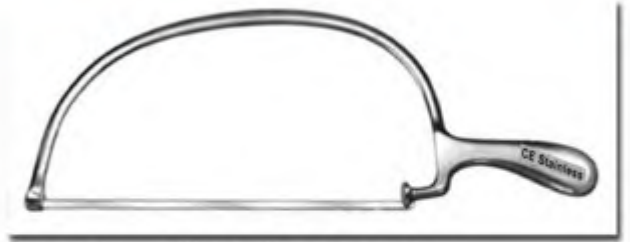

051-124 BIER Amputation Saw
40.5 cm / 16"

- 27 cm / 10 3/4" 4mm wide Spare Saw Blades
- 27 cm / 10 3/4" 6mm wide Spare Saw Blades
- 27 cm / 10 3/4" 8mm wide Spare Saw Blades



051-125 Langenbeck Amputation Saw
24.5 cm / 9 3/4"



051-126 Satterlee Amputation Saw 29 cm / 11 1/2"
Also: Spare Saw Blade Available in 20 cm / 8 1/4" Size



051-127 Charrière Amputation Saw 27 cm / 10 1/2"



051-128 Satterlee Amputation Saw 23 cm / 9"

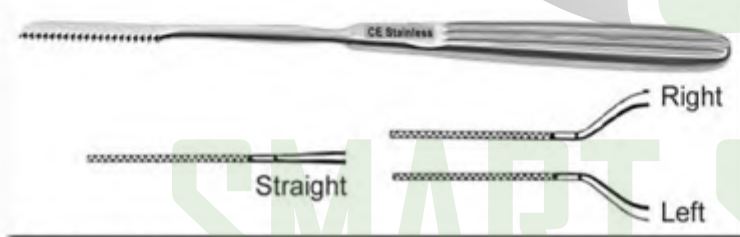

051-129 Joseph Amputation Saw 18 cm / 7"



051-130 Percy Amputation Shield 30 cm / 12"

051-131

- A: Gigli Saw 30cm
- B: Gigli Saw 50cm
- C: Tyler Gigli Saw (Large Cut) 30cm
- D: Tyler Gigli Saw (Large Cut) 30cm



051-132 Gigli
Sold in Pair

051-133 Struly Gigli
Sold in Pair



051-134
Gigli
Sold in Pair

051-135
Struly Gigli
Sold in Pair



051-136
BAILEY Gigli Saw Guide 30cm



051-137
POPPE Gigli Saw Guide 28cm



051-138
Reamer
13.5 cm / 5 1/4"



051-139
Perthes Reamer
18 cm / 7"



051-140
Perthes Reamer
21.5 cm / 8 1/2"



051-141
Reamer
One concave side
14 cm / 5 1/2"



051-142
Glenoid Punch
20cm / 8"

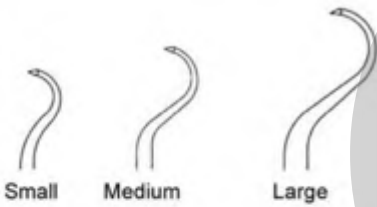

051-143
Shoulder Percussion Awl
A: 21.5cm / 8 1/2" B: 23.5cm / 9 1/4"



051-146
Shoulder Penetrating Awl
Fibre Handle
A: 18cm / 7" B: 23cm / 9"



051-144
Kuntscher Diamond Awl 28cm / 11"

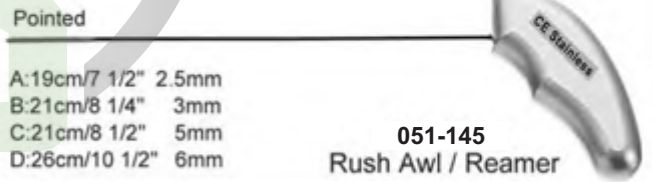

051-145
Rush Awl / Reamer

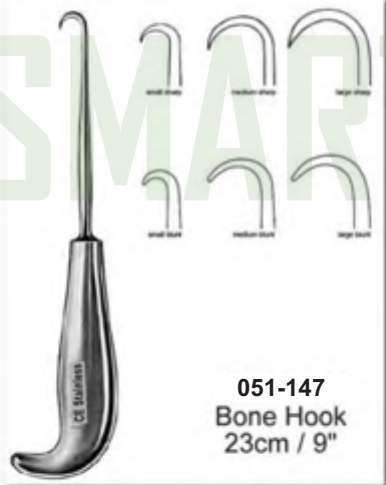

051-147
Bone Hook
23cm / 9"

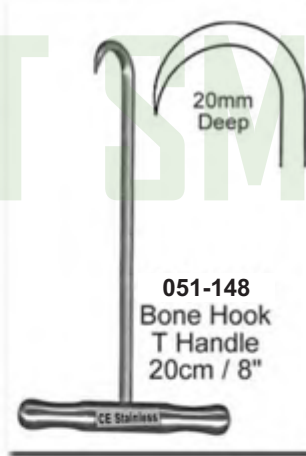

051-148
Bone Hook
T Handle
20cm / 8"



051-149
Bone Hook T Fibre Handle
14cm / 5 5/8"



051-151
Pointed Awl
Fibre Handle
25cm / 10"



051-150 Volkman Bone Hook

A: 20cm / 8" 19X27mm Sharp

B: 23cm / 9" 15X20mm Blunt

C: 23cm / 9" 15X20mm Sharp

C: 25cm / 9 3/4" 15X20mm Sharp

HAND BONE DRILLS



051-152
Stille-Sherman Hand Drill
24 cm / 9 1/2"
with 3 twist drills



051-153
Stille Hand Drill
20.5 cm / 8"
w/ 9 Twist Drills

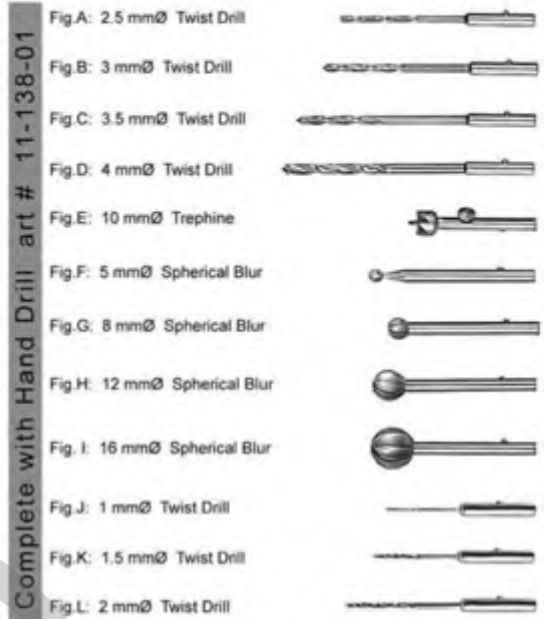

051-154

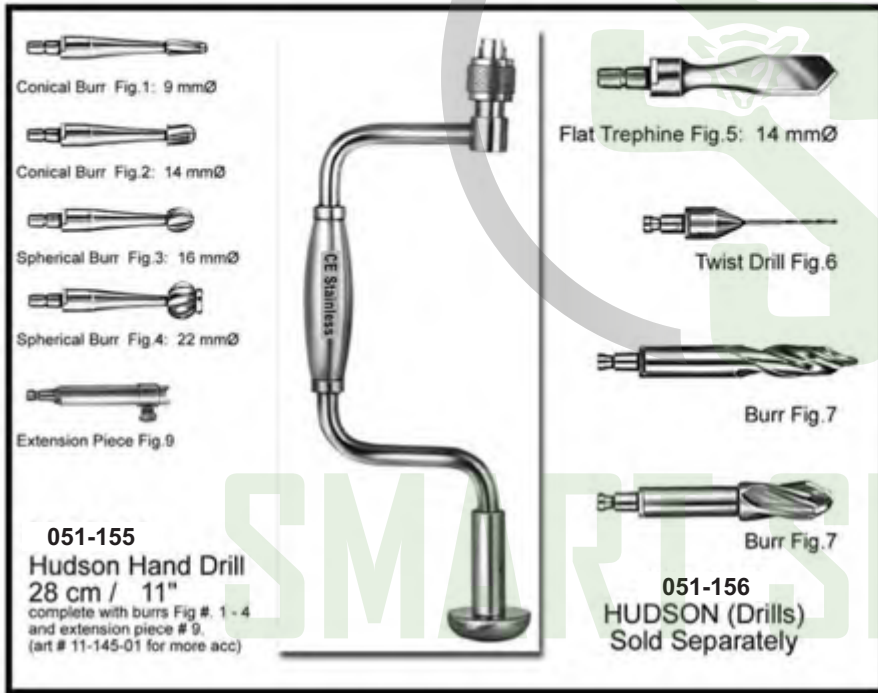

Flat Trephine Fig.5: 14 mmØ

Twist Drill Fig.6

Burr Fig.7

Burr Fig.7

051-156
HUDSON (Drills)
Sold Separately

051-155
Hudson Hand Drill
28 cm / 11"
complete with burs Fig. # 1 - 4
and extension piece # 9.
(art # 11-145-01 for more acc)

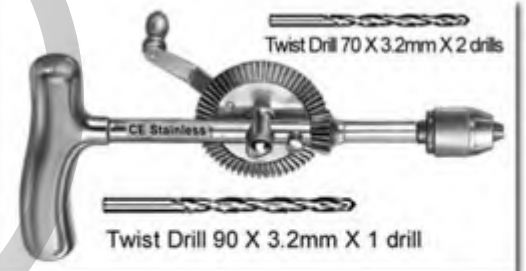

051-157 Moore Hand Drill
complete with a set of 3 twist drills

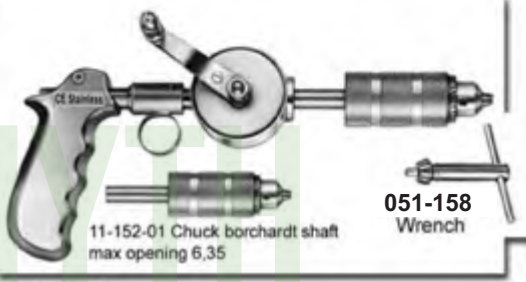

051-159
Martin Hand Drill with Chuck & Wrench

051-158
Wrench



051-160
Bunnell Hand Drill
16cm,

Longitudinally Bored with 3-Jaw-Chuck
Light Metal Housing
opening up to 4mmØ



051-161
Bunnell Type
Hand Drill 16cm,

Twin Shade Powder Coated
Longitudinally bored with 3-Jaw-Chuck
light metal housing opening up to 4mmØ



051-162
Ralk Hand Drill

Light Metal Housing
Literally Angled Handle with 3-Jaw-Chuck
and key, opening up to 6,35mmØ

HAND BONE DRILLS / KEYS

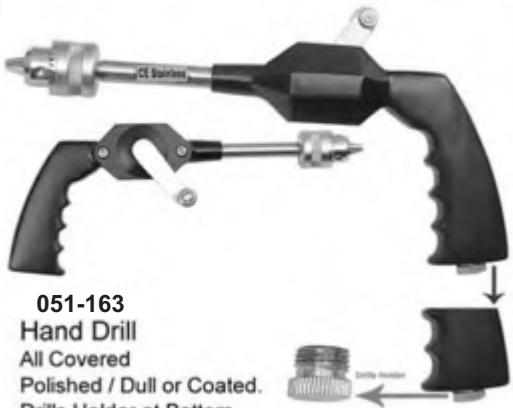

051-163
Hand Drill
All Covered
Polished / Dull or Coated.
Drills Holder at Bottom.



051-164
Hand Drill
All Covered
Light Weight
Polished / Dull or Coated.
Key Holder and Self Retaining Locking Mechanism



051-165
Box for Hand Drills W/ Art #: 11-450-00
and 11-455-00 Outside Artificial Leather
/ Inside Jumbo Foam

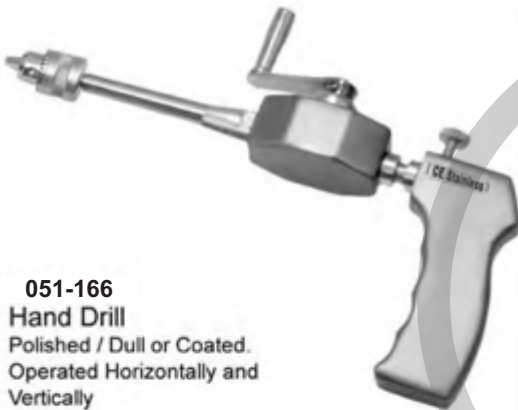

051-166
Hand Drill
Polished / Dull or Coated.
Operated Horizontally and
Vertically



Comes with Keys



051-167
Hand Drill
Polished / Dull or Coated.
All Covered

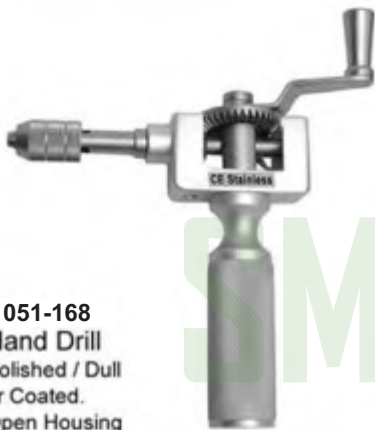

051-168
Hand Drill
Polished / Dull
or Coated.
Open Housing



051-169
Hand Drill
Polished / Dull
or Coated.
Open Housing



051-170
Hand Drill
Polished / Dull
or Coated.
Semi Closed Housing



051-171 Vickers Easidriver 14 cm / 5 1/2"



051-172 14cm / 5 1/2"
Handle W/ Chuck Longitudinally
Bored Accomodating up to 3,95mm



051-173
Handle with chuck
T-Shaped



051-174
Key



051-175
Key



051-176
Fibre T-Handle Key



051-177 5mm Borchardt Shaft Twist Drill
Long Working End

A: 2.0mm B: 2.5mm C: 3.0mm D: 3.2mm E: 3.5mm F: 4.0mm G: 5.0mm H: 6.0mm I: 7.0mm



051-178 5mm Borchardt Shaft Twist Drill

A: 1.0mm B: 1.5mm C: 1.8mm D: 2.0mm E: 2.2mm F: 2.5mm G: 2.8mm H: 3.0mm I: 3.2mm J: 3.5mm K: 4.0mm L: 5.0mm



051-179 5mm Borchardt Shaft Flat Trphine

A: 1.8mm B: 2.0mm C: 2.2mm D: 2.5mm E: 3.0mm F: 3.5mm G: 4.0mm H: 5.0mm



051-180 5mm Borchardt Shaft Spherical Burr
A: 3.0mm B: 4.0mm



051-181 5mm Borchardt Shaft Spherical Burr
A: 3.0mm B: 5.0mm

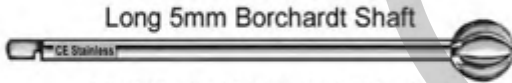

Long 5mm Borchardt Shaft

051-182 Doyen Spherical Burr
A:4mm B:6mm C:8mm D:10mm E:12mm F:14mm G:16mm

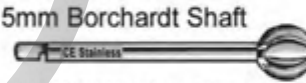

Short 5mm Borchardt Shaft

051-183 Doyen Spherical Burr
A:4mm B:6mm C:8mm D:10mm E:12mm F:14mm G:16mm



051-184 Doyen Conical Burr
Coarse Spacing 12mm Dia



051-185 Doyen Conical Burr
Fine Spacing A:8mm / B:10mm



051-186 Doyen Cylindrical Burr
Coarse Spacing A:12mm / B:15mm



051-187 Albee Burr Oval
Coarse Spacing A:8mm / B:10mm / C:12mm



051-188 Albee Burr Pointed
7mm



051-189 Borchardt Burr Oval
Coarse Spacing 13mm



051-190 Flat Burr
Short Borchardt Shaft 25mm



051-191 Toti Trephine
Short Borchardt Shaft 8mm

BONE HOLDING CLAMPS



051-192 Standard

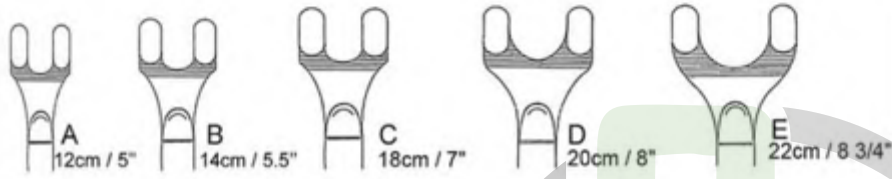

Gerster-Lowman Bone Holding Clamp



051-193 Angled

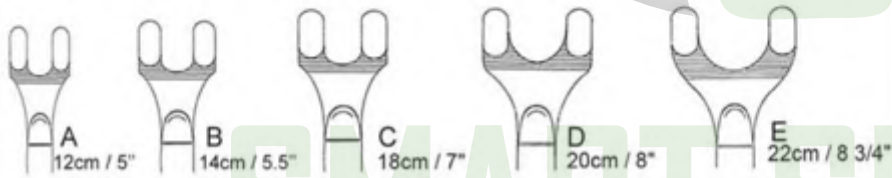

Gerster-Lowman Bone Holding Clamp

051-194 Gerster Traction Bar 15cm / 6"



Gerster-Lowman Bone Holding Clamp



Gerster-Lowman Bone Holding Clamp



051-197 Flat Nose Plier
18.5 cm / 7 1/4" Parallel Grip SS



051-198 Flat Nose Plier / Cutter
18.5 cm / 7 1/4" Parallel Grip



051-199 Long Nose Plier / 22 cm / 8 1/4"



051-200
Vise Grip 20.5 cm / 8"
Stainless Steel



SLAP HAMMER w/ Threaded Shaft Head
to be used with **051-201** and **051-202**



SLAP HAMMER w/ Hexa Shaft Head
to be used with **051-201** and **051-202**



051-203 Regular Jaw Locking Plier
A: 18 cm / 7" B: 20 cm / 8"
C: 23 cm / 9"



051-204
Vise Grip 23 cm / 9"
Locking Plier



051-205
Vise Grip 20.5 cm / 8"
Locking Plier



051-206
Vise Grip 18 cm / 7"
Locking Plier



051-207
Needle Nose Locking Plier
30 cm / 12"



051-208
Needle Nose Locking Plier
25.5 cm / 10"



051-209
Needle Nose Locking Plier
22 cm / 8.5"



051-210
Needle Nose Locking Plier
A: 22 cm / 8.5"
B: 25.5 cm / 10"
C: 30 cm / 12"

BENDING - WIRE CUTTING PLIERS



051-211
Combi-Flat Nose Pliers 15 cm / 6"
for Bending & Cutting



051-210 Round / Flat Nose Pliers
18 cm / 7"



051-215 Flat Nose Pliers
17 cm / 6 3/4" with crosswise groove



051-218
Platypus Nail
Pulling Forceps
15.5 cm / 6 1/4"

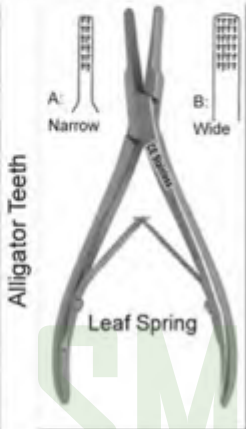

051-219
Platypus Nail
Pulling Forceps
15.5 cm / 6 1/4"



051-212
Flat Nose Pliers
18 cm / 7"
Parallel Grip



051-216
Flat Nose Pliers 17.5 cm / 7"



051-213 Flat Nose Pliers
13.5 cm / 5 1/4"



051-214 Hackstock Flat
Nose Pliers 16cm / 6 1/4"



051-217
Flat Nose Pliers Pointed 19.5 cm / 7 3/4"



051-220
Round Nose Pliers
15.5 cm / 6 1/4"



051-221
Needle Nose Pliers
15.5 cm / 6 1/4"

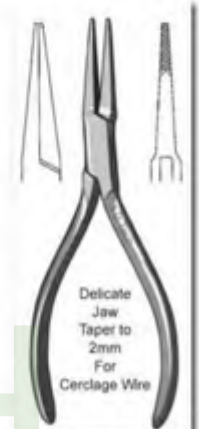

051-222
Flat Nose Pliers
15 cm / 6"

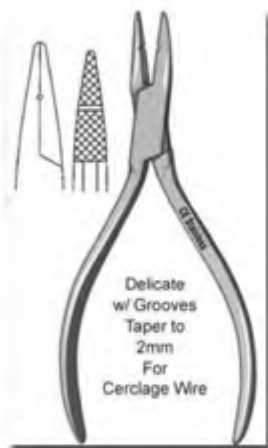

051-223
Needle Nose Pliers
13.5 cm / 5 1/4"

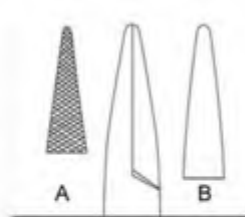

051-224
Needle Nose Pliers
Taper to 2mm Tip
14 cm / 5 1/2"
A: Fine Cross Serration
B: Smooth



051-225
18.5 cm / 7 1/4"
Wire Cutting Pliers
Hard wires up to 1.8mm Ø



051-226
Martin "Diamant"
Hard wires up to 1.5mm Ø

BENDING - WIRE CUTTING PLIERS



051-227
14 cm / 5 1/2"
Circlage Pliers / Cutter



051-228
20 cm / 8"
Wire Bending Pliers

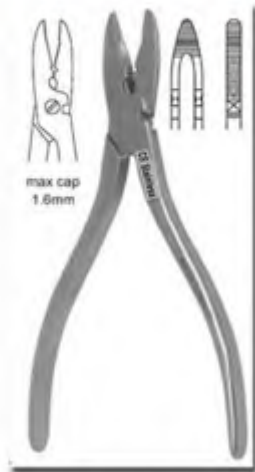

051-229
15 cm / 6"
Wire Bending Pliers



051-230
20 cm / 8"
Wire Bending Pliers
TUNGSTEN
CARBIDE



051-231
15 cm / 6"
Needle Nose Pliers



051-232
14 cm / 5 1/2"
Flat Nose Pliers

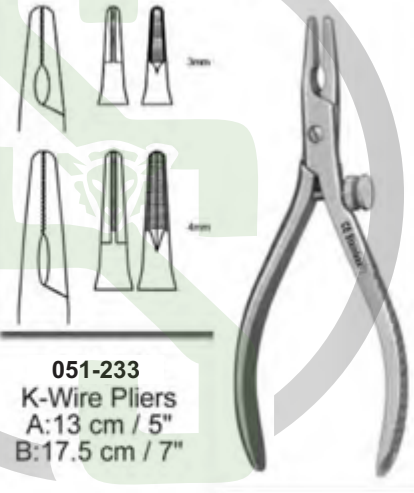

051-233
K-Wire Pliers
A: 13 cm / 5"
B: 17.5 cm / 7"



051-234
19 cm / 7 1/2"
Screw/Pin
Removing Pliers



051-235
14 cm / 5 1/2"
Pin Puller
Grips Small Pins



051-236
16 cm / 6 1/2"
Flat Nose Pliers
w/ Cutter
for Cerclage Wire



051-237
19 cm / 7 1/2"
Narrow
Nose Pliers
Heavy Jaws
for Pulling
Wire / Pins



051-238
17.5 cm / 7"
Long Jaw Pliers
2inch Long Jaw
Delicate

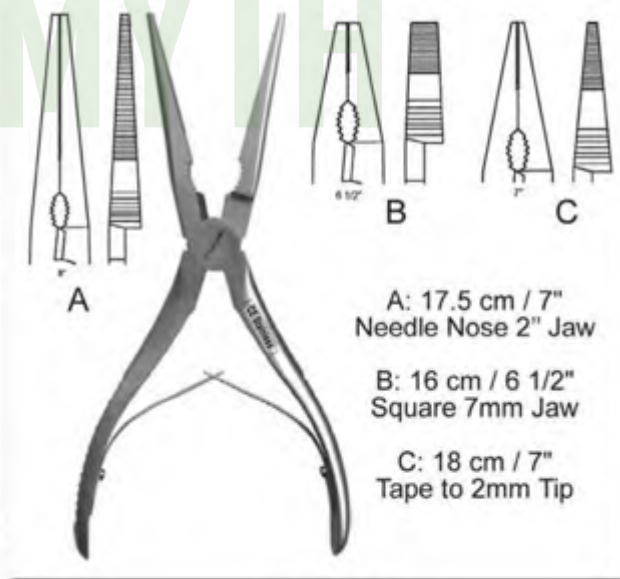

051-239
UNIVERSAL Pliers
Serrated w/ Heavyduty Spring and Cutting Edge
Max Cutting Cap: 1.1mm

BENDING - PASSERS ETC

All TUNGSTEN CARBIDE

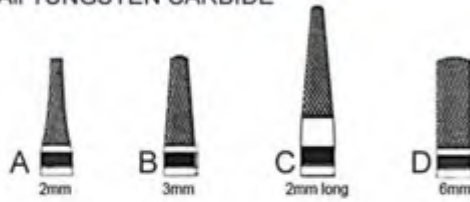

- A: 2mm Delicate Jaw TC
- B: 3mm Jaw TC
- C: 2mm Long Jaw TC
- D: 6mm Jaw TC



051-242
18 cm / 7"
Double Action Wire Extraction Plier



051-240
20 cm / 8"
Slip Joint Pliers



051-241
21 cm / 8 1/2"
Lineman Pliers



051-243 19 cm / 7 1/2" Gratloch Wire Bender



051-244
13.5 cm / 5"
K-Wire / Plate Bender



051-245
14.5 cm / 5 1/2"
K-Wire / Plate Bender

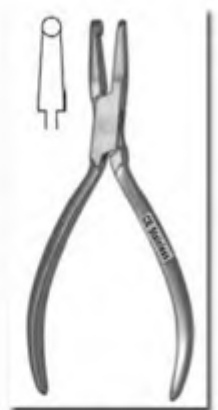

051-246
13.5 cm / 5"
Mini Plate Bending Pliers

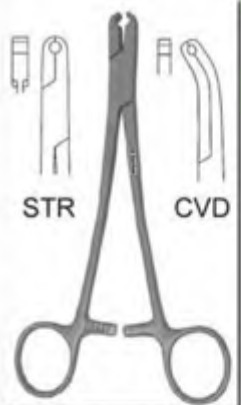

051-247
18 cm / 7 1/4"
Rod Holder
A: 4.0mm Rod
B: 4.76mm Rod
C: 6.35mm Rod
Straight or Curved

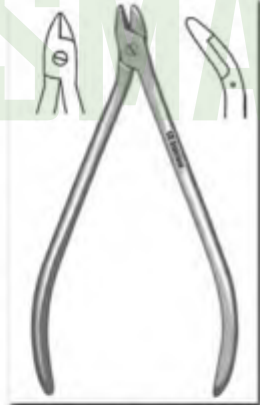

051-248
14.5 cm / 5 1/2"
Plate Bending Pliers



051-249
16 cm / 6 1/2"
Wire Pulling Forceps

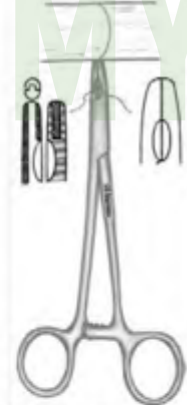

051-250
16 cm / 6 1/4"
Wire Twister / Tightener

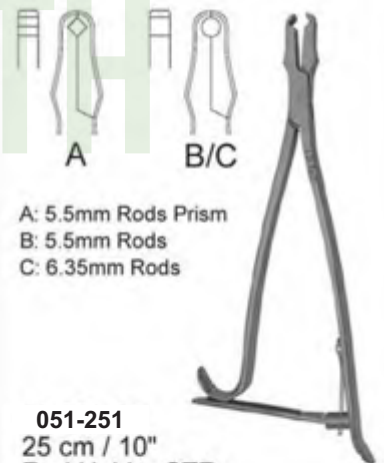

- A: 5.5mm Rods Prism
- B: 5.5mm Rods
- C: 6.35mm Rods

051-251
25 cm / 10"
Rod Holder STR



051-252
21 cm / 8 1/2"
Rod Gripper
Adjustable



BONE WIRE MANAGEMENT



051-253
Loute Wire Tightener (21 cm / 8 1/4")



051-254
Wire Tightener
w/ T Handle
11 1/2 cm / 4 1/2"



051-255
Wire Tightener 12 cm / 4 3/4")

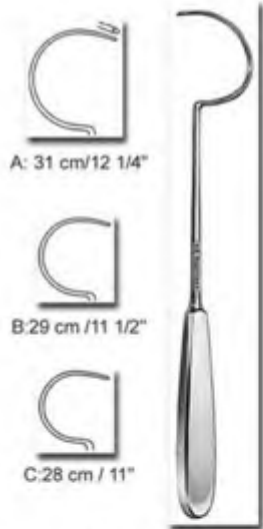

A: 31 cm / 12 1/4"
B: 29 cm / 11 1/2"
C: 28 cm / 11"

051-256
Demel Wire Guide



CVD
Crochet Hook
18cm / 7 1/4"

051-257
Bankert Ligature Carrier



CVD
Crochet Hook
Fiber Handle
A: 18cm / 7"
B: 23cm / 9"

051-258
Suture Passer



CVD
Suture Hole
Fiber Handle
A: 18cm / 7"
B: 23cm / 9"

051-259
Suture Passer



Suture Hole
20cm / 8"
A: Right Blunt
B: Left Blunt
C: Right Sharp
D: Left Sharp

051-260
Deschamps Ligature Carrier



A: 9X7.5CM
Wire: 2.4MM X 13cm
B: 16X9CM
Wire: 3.2MM X 18cm
C: 21X15CM
Wire: 4MM X 23cm

051-261
Böhler Extension
Bow for femur & knee

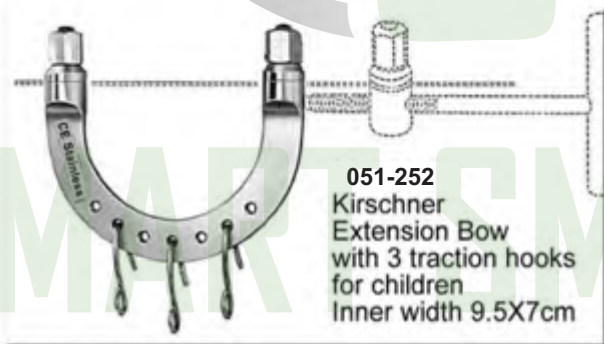

051-252
Kirschner
Extension Bow
with 3 traction hooks
for children
Inner width 9.5X7cm

051-262
for Wrist / Ankle
10.5X10.5cm

051-263
for Elbow
12X12cm

051-264
for Knee
15.5X15.5cm

051-265
for Femur
20X15.5cm



051-266 (Kirschner) Extension Bow
A: Small: 18.5 cm / 7 1/4"
B: Large: 26.5 cm / 10 1/2"
with 3 traction hooks



051-267
Wire Strainer 18.5 cm / 7 1/4"



051-268
Extension Bow
A: 10 1/2" X 6 1/4"
B: 7" X 4"



051-269
Fixation Discs
for wire drills, pair

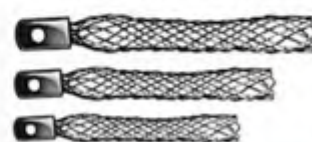

051-270 Extension Sleeve
Small / Medium / Large

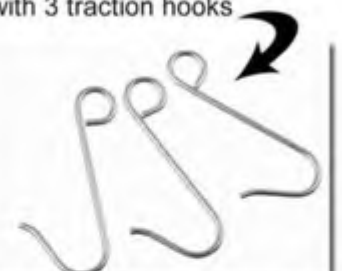

051-271 Traction Hook
for Extension Bows

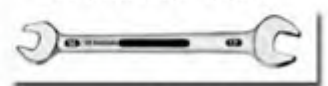

051-272
Wrench 20cm / 8"



051-273
Martin-Ideal
Finger Nail Drill



14 cm / 5 1/2"
051-277
Radolf
Nail Extracting Forceps

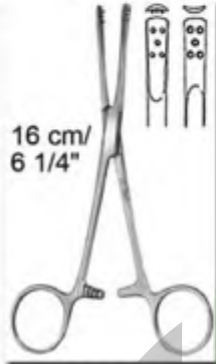

16 cm / 6 1/4"
051-278
Nail Extracting
Forceps

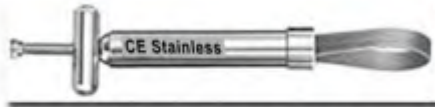

051-274 Feldheim Tourniquet
10cm / 4"



051-279
Martin Finger
Ring Saw 18.5 cm / 6 3/4"
Spare Blades are Available
Separately



051-275
Walton
Finger Ring Saw
16 cm / 6 1/4"
Spare Blades are
provided separately



051-276
Finger Ring Saw
17 cm / 6 3/4"
Spare
Blades are provided separately



051-280
Finger Ring Saw Cutter Spare



051-281 Lead Hand for Kids / Adults



051-282 Lead Hand for Kids / Adults



051-283
Chamy-OSU Bone Biopsy Instruments
Consisting of trocar, a toothed trephine
and a plunger for taking tibial and
iliac bone grafts through a closed technique
22 cm / 8 3/4"



051-284
Chamy Cancellous Bonegraft Mill
Outer Dia: 17mm
Inner Dia: 16mm



051-285
Chamy Bone Biopsy Instruments
A: Outer Dia: 5mm Inner Dia: 4mm
B: Outer Dia: 8mm Inner Dia: 7mm
22 cm / 8 3/4"

TAMPER - IMPACTORS - PACKERS

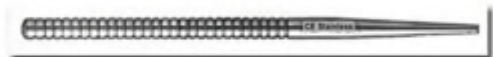

051-286 15.5cm/6"
Bone Tamper Tip Sizes:
2-3-4-5-6-8-10mm



A:2mm
B:3mm
C:4mm
D:5mm

F: 6mm
G: 8mm
H: 9mm
I: 10mm

051-289
Bone Tamper

Knurling Handle



051-287 17cm / 6 1/2"
Bone Impactor / Teflon Tip



3mm 5mm 8mm
Cross-Serrated
A: 3mm
B: 5mm
C: 8mm

051-288 20cm / 8"
Caspar Bone Tamper

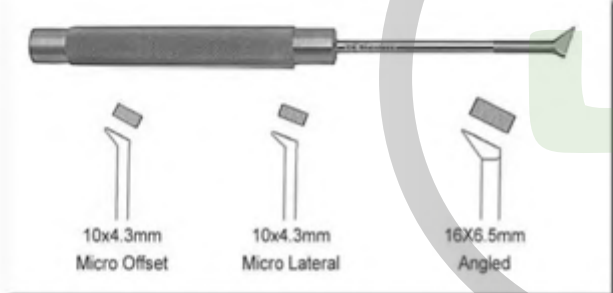

10x4.3mm Micro Offset
10x4.3mm Micro Lateral
16X6.5mm Angled

051-290 21cm / 8 1/2" Lumbar / Cervical Impactor

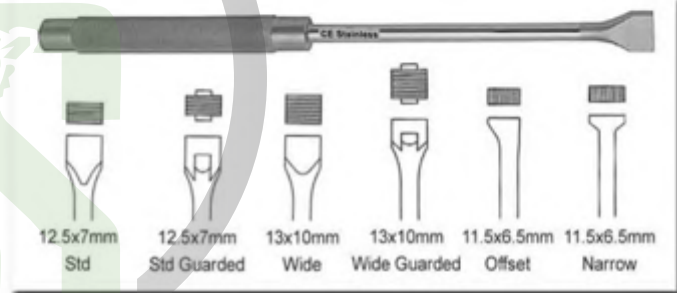

12.5x7mm Std
12.5x7mm Std Guarded
13x10mm Wide
13x10mm Wide Guarded
11.5x6.5mm Offset
11.5x6.5mm Narrow

051-291 21cm / 8 1/2" Lumbar / Cervical Impactor

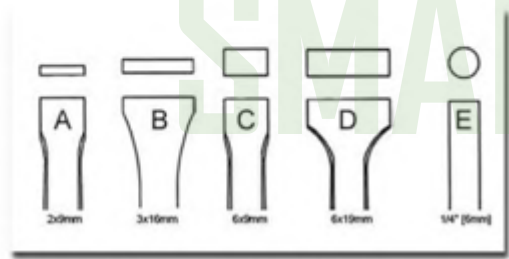

A: 2.X9mm B: 3X16mm
C: 6X9mm D: 6X19mm
E: 6mm Dia

051-292 25cm / 10"
Bone Chip Packer



9.5mm DIA



051-293 43cm / 17"
Bone Tamper



BONE FILES - RASPS



051-294 Putti Bone Rasp Round / Semi Round
30cm / 11 3/4"



051-295 Putti Bone Rasp Curved / Straight
27cm / 10 3/4"



051-296 Bone File 28 cm / 11" w/ Hollow Handle
Semi Round



051-297 Bone File 24.5 cm / 9 3/4"
w/ Hollow Handle Semi Round



051-298 Bone File 22 cm / 8 3/4"
Flat / Round



051-299 Bone Rasp 22 cm / 8 3/4"
Flat / Round



051-300 Bone File 18 cm / 7"
Fibre Handle / Cross-Hatch



051-301 Bone File 18 cm / 7"
Fibre Handle / Linear



Half Round

051-302 Bone File 18 cm / 7"
Fibre Handle / Straight



Half Round

051-303 Bone File 18 cm / 7"
Fibre Handle / CVD Forward



Half Round

051-304 Bone File 18 cm / 7"
Fibre Handle / CVD Backward

Diamond Coated



051-305 Bone File 18 cm / 7"
Fibre Handle / STR Diamond Coated

Diamond Coated



051-306 Bone File 18 cm / 7"
Fibre Handle / CVD Diamond Coated

BONE FILES - RASPS

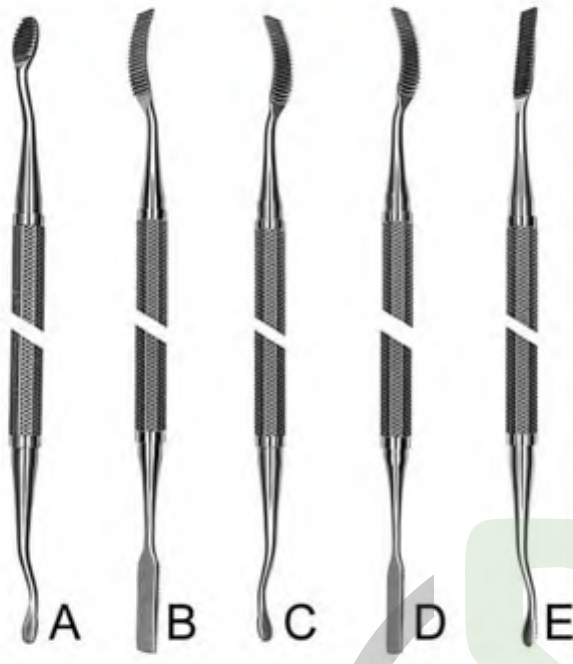

051-307 A/B/C/D/E
Miller-Colburn Bone File 18 cm / 7" Downwards Cut

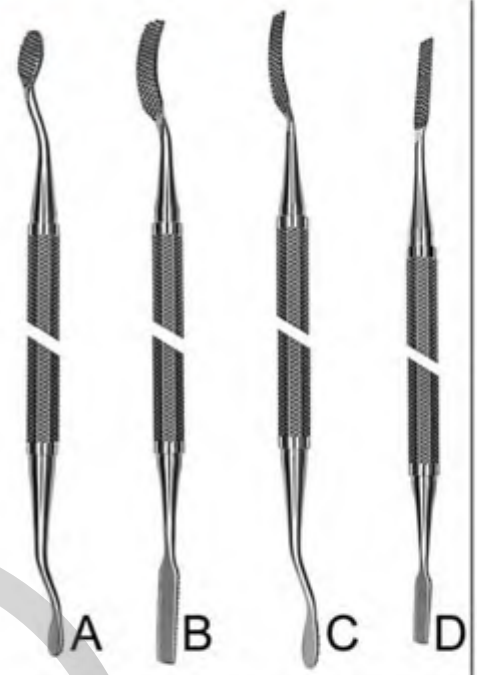

051-308 A/B/C/D/
Miller-Colburn Bone File 18 cm / 7" Cross Cut



051-309
Bone Rasp
21 cm / 8.5"
13mm
Fine/Coarse
Straight



051-310
Bone Rasp
Joseph
16cm / 6.25"
8mm
Fine Cross Serr
Straight



051-311
Bone Rasp
Lewis
19cm / 7.5"
8mm
Straight

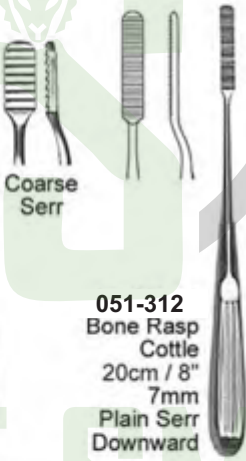

051-312
Bone Rasp
Cottle
20cm / 8"
7mm
Plain Serr
Downward



051-313
Bone Rasp
Maltz
18cm / 7"
9mm
Plain
Coarse Serr
Downward

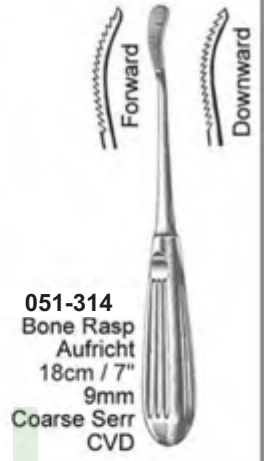

051-314
Bone Rasp
Aufrecht
18cm / 7"
9mm
Coarse Serr
CVD



051-315
Bone Rasp
Fomon
21 cm / 8.5"
8mmX40mm
Coarse Serr
4 Sided
Flat / Convex Blades



051-316
Bone Rasp
Fomon
21 cm / 8.5"
8mmX40mm
Fine Serr
4 Sided
Flat / Convex Blades



051-317
Bone Rasp
Kleinert Kurtz
21 cm / 8.5"
8mmX45mm
Fine/Coarse Serr
4 Sided
Flat / Convex Blades



051-318
Bone File / Rasp
21 cm / 8.5"
18mm
Fine / Coarse Serr

RETRACTORS - BONE LEVERS

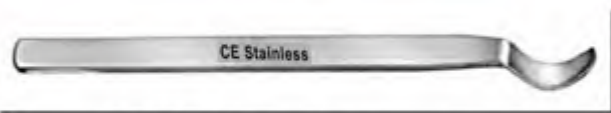

051-319 Bone Lever
16 cm / 6 1/4"



051-322 Hohman, Mini Bone Lever
16 cm / 6 1/4" 14 mm tip



051-324 Hohman, Mini Bone Lever 12 cm / 4 3/4" 14 mm tip

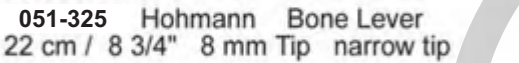

051-325 Hohmann Bone Lever
22 cm / 8 3/4" 8 mm Tip narrow tip



051-330 Hohmann Bone Lever
23.5 cm / 9 1/4" 43 mm Tip narrow tip



051-331 Lange-Hohmann Bone Lever
25 cm / 9 3/4" 22mm Tip wide tip with groove



051-334 Hohmann Bone Lever 27.5 cm / 10 3/4"
24mm Tip wide, round tip



Sizes Available
A: 75X30mm
B: 100X30mm

051-338 A / B
Taylor Spinal Retractor
16 cm/6 1/4" pointed end



051-320 Hohman, Mini Bone Lever 16 cm / 6 1/4" 6mm tip



051-323 Hohman, Mini Bone Lever 16 cm / 6 1/4" 8 mm tip



051-327 Hohmann Bone Lever
13cm/5" A:3mm B:5mm C:7mm



051-328 Hohmann Bone Lever
23.5 cm / 9 1/4" 18 mm Tip narrow tip



051-329 Hohmann Bone Lever 29 cm / 11 1/2"
35mm Tip wide tip



051-333 A / B
Bennett Bone Lever
24 cm / 9 1/2"



051-336 Blount Knee Retractor
26.5 cm / 10 1/2" blunt



051-337 Blount Knee Retractor
26.5 cm / 10 1/2"



051-340 Blount
Knee Retractor
17.5 cm / 7"



051-332 Hohmann Bone
Lever 25 cm / 9 3/4" 70 mm Tip narrow tip



051-335 Hohmann
Bone Lever
23.5 cm / 9 1/4" 43mm Tip narrow tip



051-339 Hohmann Bone Lever 25.5 cm / 10"
22mm Tip wide tip

RETRACTORS - BONE LEVERS



051-341 Fukuda Retractor
19 cm / 7 1/2" T Handle

A: 32X81mm
B: 38X81mm



051-342 Browne - Deltoid Retractor
28 cm / 11" T Handle w/ Ring



051-343 Humeral Head Retractor
18 cm / 7" Strong Curved

2 Blunt Prongs

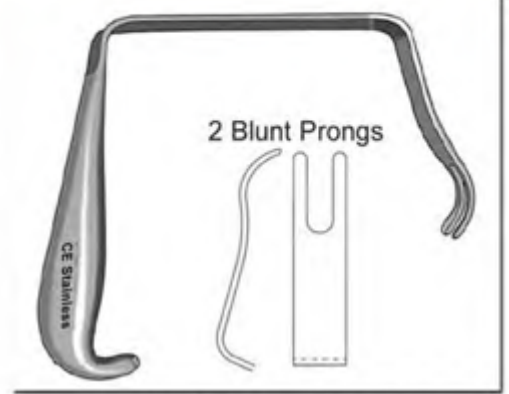

051-344 Bristow / Bankart Humeral Retractor
18 cm / 7"

2 Blunt Prongs



051-345 Capsule Retractor
25 cm / 10"

22mm Blade
1 Sharp Prong



051-346 Capsule Retractor
25 cm / 10"

22mm Blade
2 Sharp Prong



051-347 Capsule Retractor
25 cm / 10"

22mm Blade
3 Sharp Prong

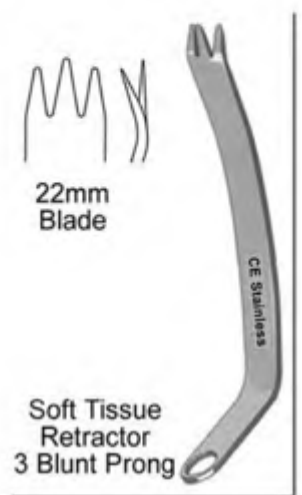

051-348 Bristow/Bankart
19 cm / 7 1/2"

22mm Blade

Soft Tissue Retractor
3 Blunt Prong



051-349 Blade Retractor
19 cm / 7 1/2"

A: 13MM
B: 18mm
C: 20mm
D: 23mm



051-350 Smillie Retractor
13cm / 5"

13X18mm Blade
T Handle



051-351 Smillie Retractor
14cm / 5 1/2"

13X55mm Blade
T Handle



051-352 Smillie Retractor
Angled Blade 14cm / 5 1/2"

Small: 19X32mm
Medium: 19X45mm
Large: 19X60mm
T Handle



051-353 Z Knee Retractor
15 cm / 6"

Medium Blade:
57/69mm Deep
11mm Wide

Large Blade:
63/76mm Deep
11mm Wide



051-354 Knee Retractor
22 cm / 8 1/2" Ring Handle

9X38mm Blade

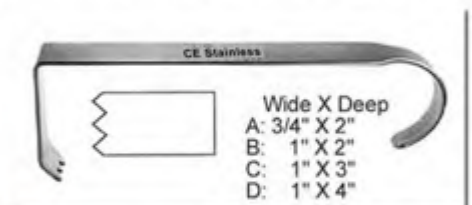

051-355 Hibbs Retractor
24 cm / 9 1/2" Sharp Teeth

Wide X Deep
A: 3/4" X 2"
B: 1" X 2"
C: 1" X 3"
D: 1" X 4"

RETRACTORS - BONE LEVERS

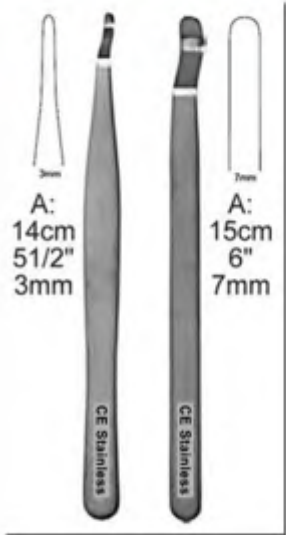

051-356
Hayes Retractor

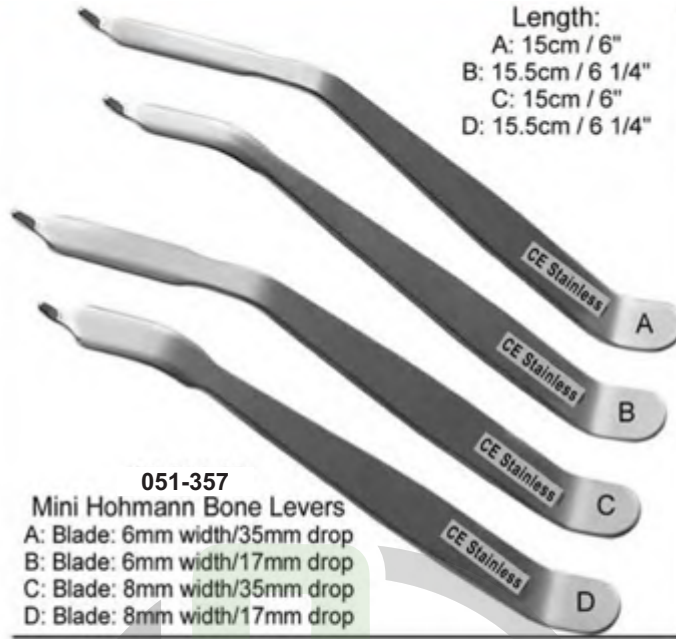

051-357
Mini Hohmann Bone Levers
A: Blade: 6mm width/35mm drop
B: Blade: 6mm width/17mm drop
C: Blade: 8mm width/35mm drop
D: Blade: 8mm width/17mm drop

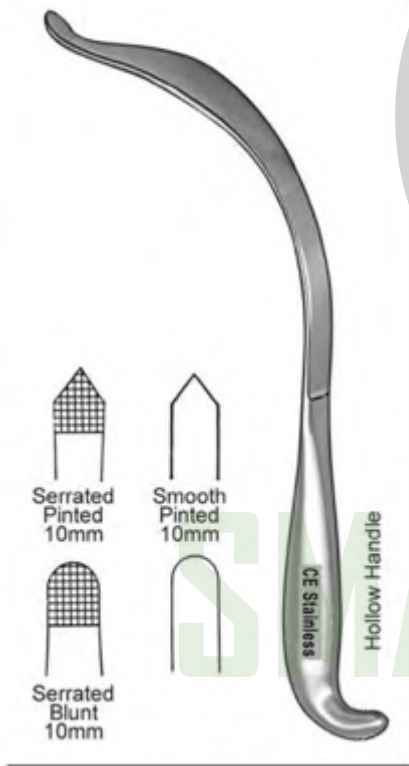
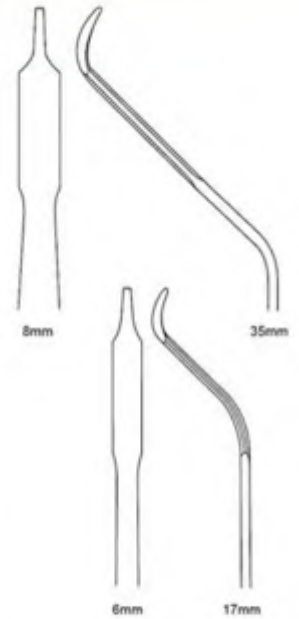

051-358
Aufranc Cobra Retractor
A: 26cm / 10 1/2 inch

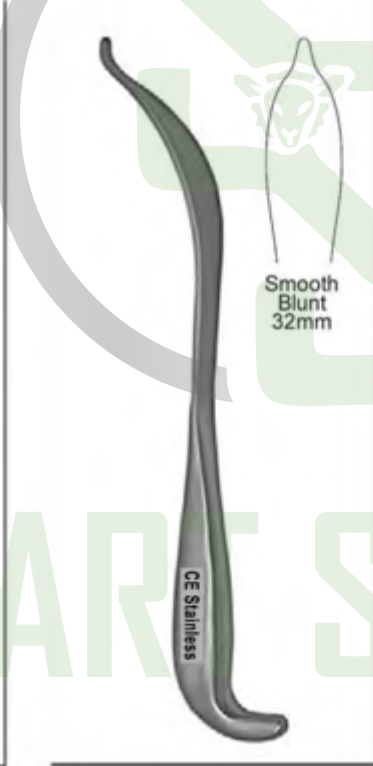

051-359
Aufranc Cobra Retractor
A: 27.5cm / 11 inch



051-360
Humeral Head Retractor
23cm / 9 inch

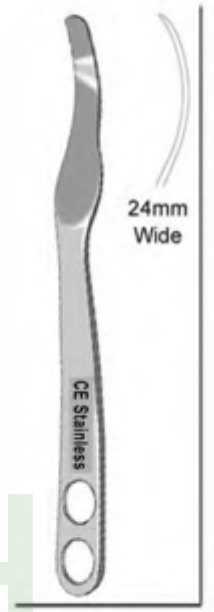

051-361
Pelvic Retractor
Single Prong
A: 26cm / 10 1/2 inch

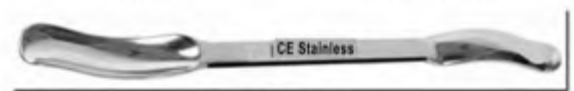

051-362
Murphy Bone Skid
30cm / 12 inch

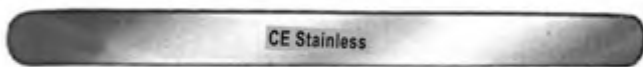

051-363
Ribbon Retractor Malleable
30cm / 12 inch

Sizes Available

- A: 6" X 6mm
- B: 6" X 12mm
- C: 6" X 16mm
- D: 6" X 19mm
- E: 7 1/2" X 25mm

- F: 8" X 6mm
- G: 8" X 10mm
- H: 8" X 12mm
- I: 8" X 16mm
- J: 8" X 19mm

- K: 13" X 19mm
- L: 13" X 30mm
- M: 13" X 38mm
- N: 13" X 45mm
- O: 13" X 50mm
- P: 13" X 65mm
- Q: 13" X 75mm

051-364
St. Mark's Pelvic Retractor
Angled Blade

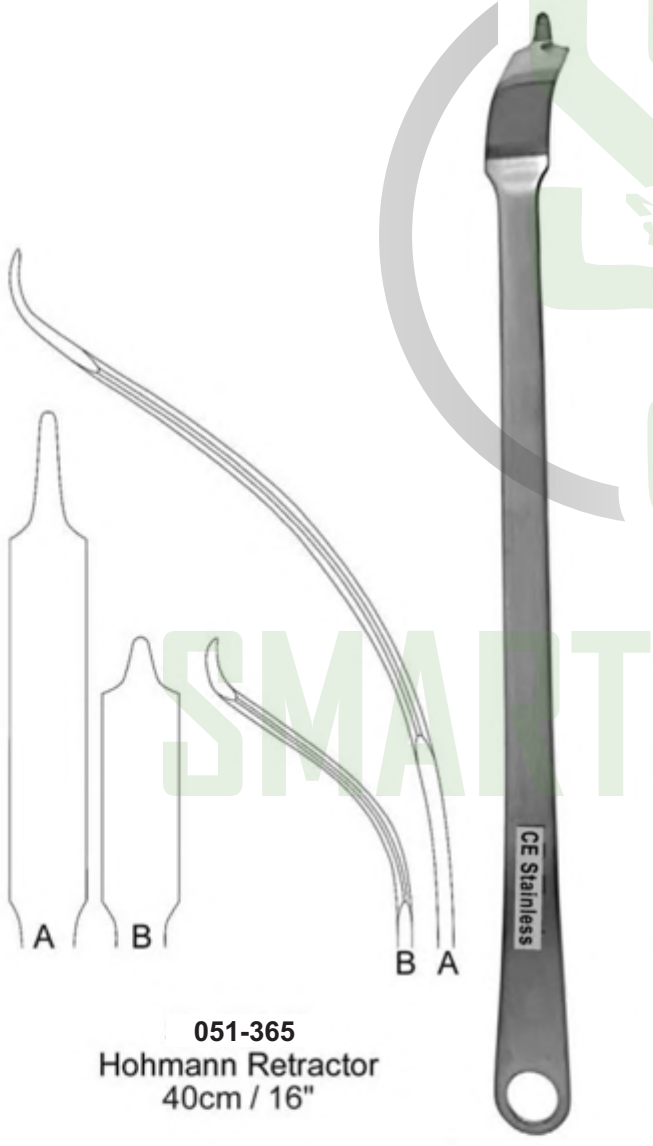
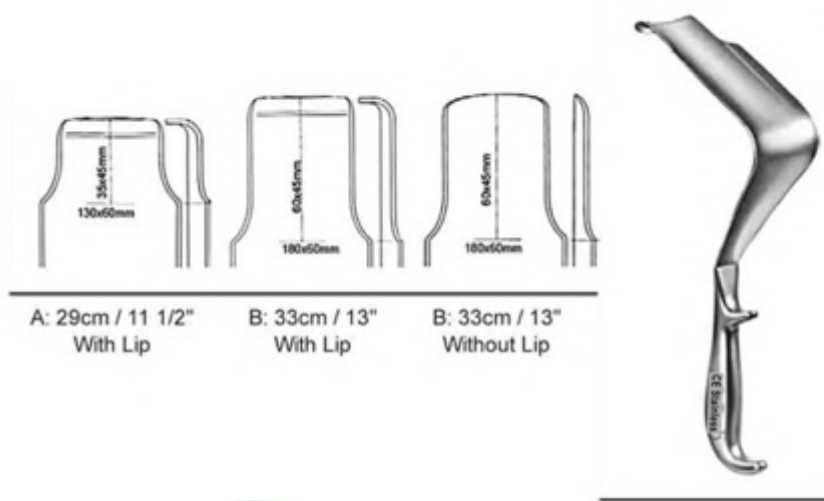

051-365
Hohmann Retractor
40cm / 16"

- A: 22mm Blade
2 Finger Rings Long Round → 
- B: 22mm Blade
1 Finger Ring Short Round → 

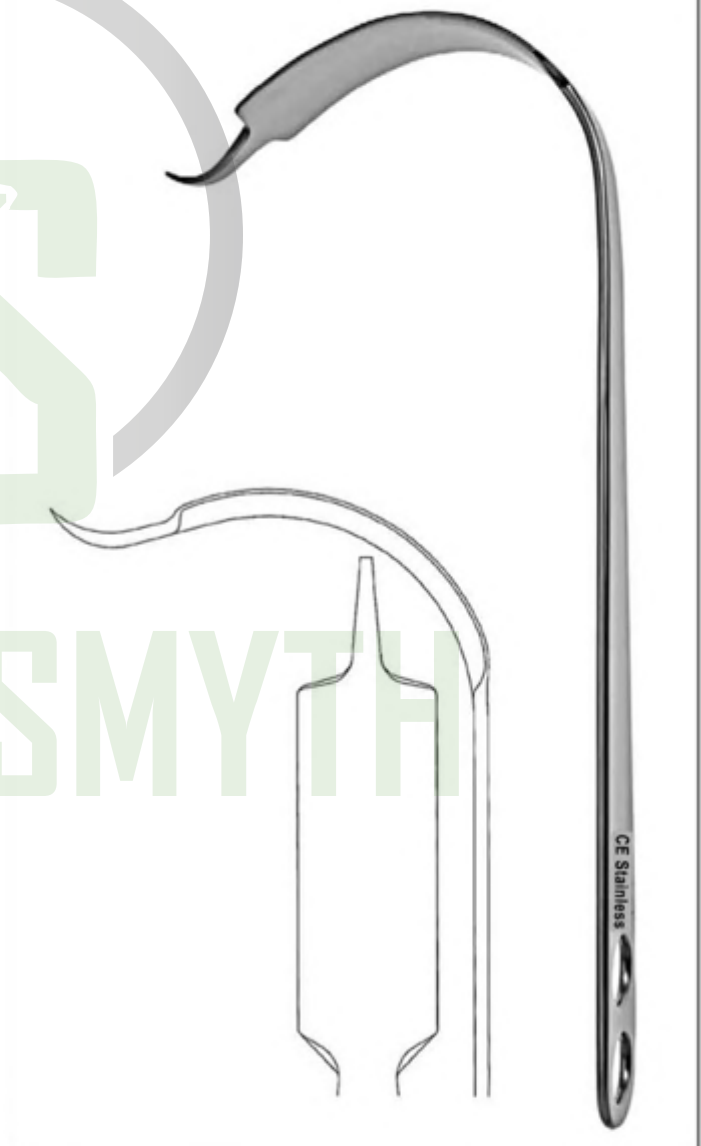

051-366
Hohmann Retractor
33cm / 13"
40mm Blade Width



051-367
Virchow
Skull Breaker
7.5cm / 3"

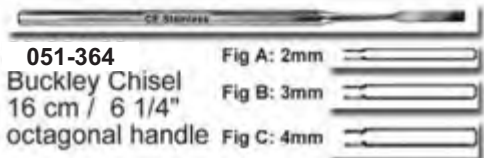

051-364
Buckley Chisel
16 cm / 6 1/4"
octagonal handle

Fig A: 2mm
Fig B: 3mm
Fig C: 4mm

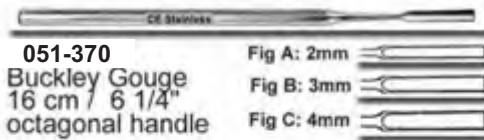

051-370
Buckley Gouge
16 cm / 6 1/4"
octagonal handle

Fig A: 2mm
Fig B: 3mm
Fig C: 4mm

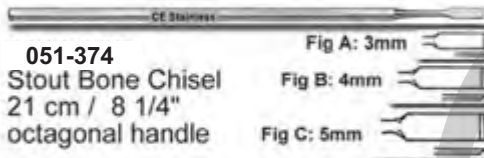

051-374
Stout Bone Chisel
21 cm / 8 1/4"
octagonal handle

Fig A: 3mm
Fig B: 4mm
Fig C: 5mm

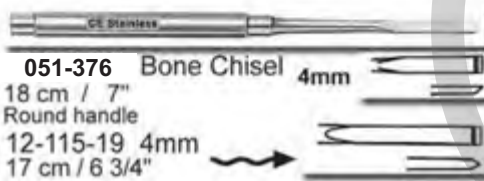

051-376 Bone Chisel
18 cm / 7"
Round handle
12-115-19 4mm

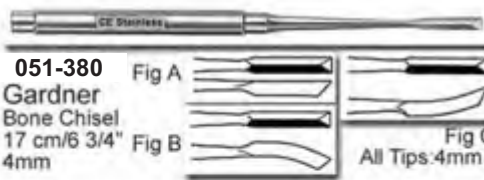

051-380 Gardner
Bone Chisel
17 cm/6 3/4"
4mm

Fig A
Fig B
All Tips: 4mm
Fig C

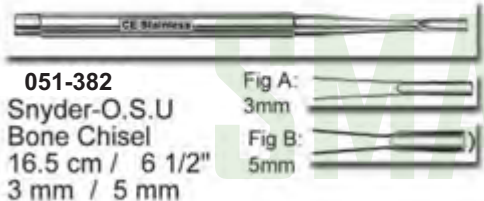

051-382
Snyder-O.S.U
Bone Chisel
16.5 cm / 6 1/2"
3 mm / 5 mm

Fig A:
3mm
Fig B:
5mm

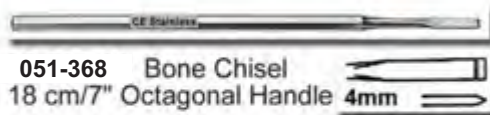

051-368 Bone Chisel
18 cm/7" Octagonal Handle 4mm

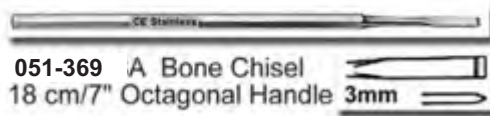

051-369 A Bone Chisel
18 cm/7" Octagonal Handle 3mm



051-371
Osteotome
13.5 cm/5 1/4"

Fig:A 8mm
Fig:B 10mm
Fig:C 12mm
Fig:D 14mm
Fig:E 16mm



051-375
Chisel
13.5 cm/5 1/4"

Fig:A 8mm
Fig:B 10mm
Fig:C 12mm
Fig:D 14mm
Fig:E 16mm



051-377
Gouge
13.5 cm / 5 1/4"

Fig:A 8mm
Fig:B 10mm
Fig:C 12mm
Fig:D 14mm
Fig:E 16mm

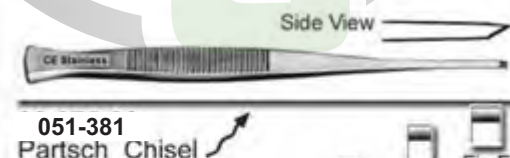

051-381
Partsch Chisel
13.5 cm/5 1/4"
&
17cm/6 3/4"

Fig:A 2mm
Fig:B 3mm
Fig:C 4mm
Fig:D 5mm
Fig:E 6mm

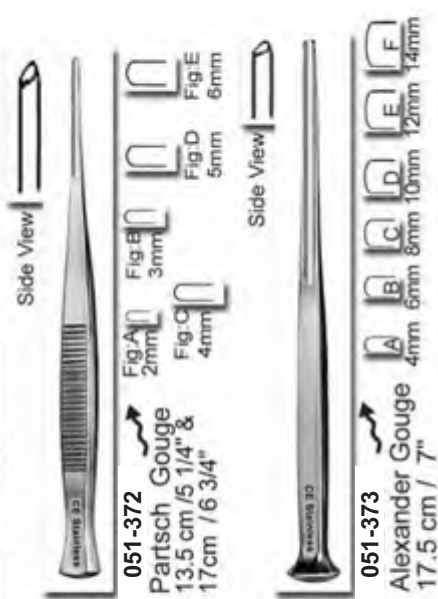

051-372
Partsch Gouge
13.5 cm / 5 1/4" &
17cm / 6 3/4"

051-373
Alexander Gouge
17.5 cm / 7"

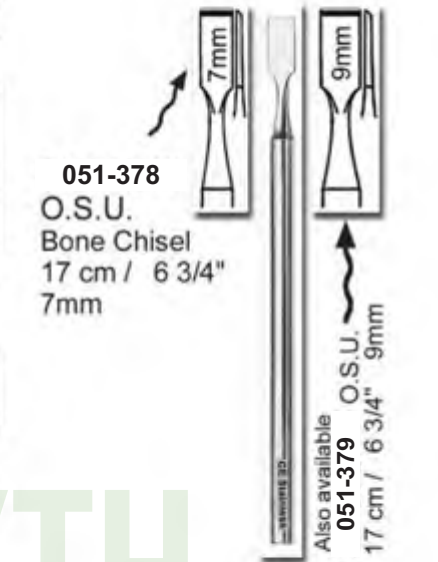

051-378
O.S.U.
Bone Chisel
17 cm / 6 3/4"
7mm

Also available
051-379 O.S.U.
17 cm / 6 3/4" 9mm

TIP

Three sizes in Lambotte Mini Osteotome (see below)

Available Tip Sizes: 2mm/3mm/4mm/6mm/8mm/10mm/12mm/15mm

051-384 (12.5 cm / 5")
Lambotte, Mini Osteotome

051-385 (17 cm / 6 3/4")
Lambotte, Mini Osteotome
3mm / 4mm / 6mm /
8mm / 10mm / 12mm / 15mm

051-386 (24 cm / 9 1/2")
Lambotte, Osteotome
15mm / 20mm / 25mm /
30mm / 38mm / 44mm / 50mm

Available in:
15mm
20mm
25mm
30mm
38mm
44mm
50mm

051-383
Lambotte, Osteotome
24 cm/9 1/2"

Other Lambotte Mini Osteotomes sizes / Tips

For Image, please see photo of above Osteotome.

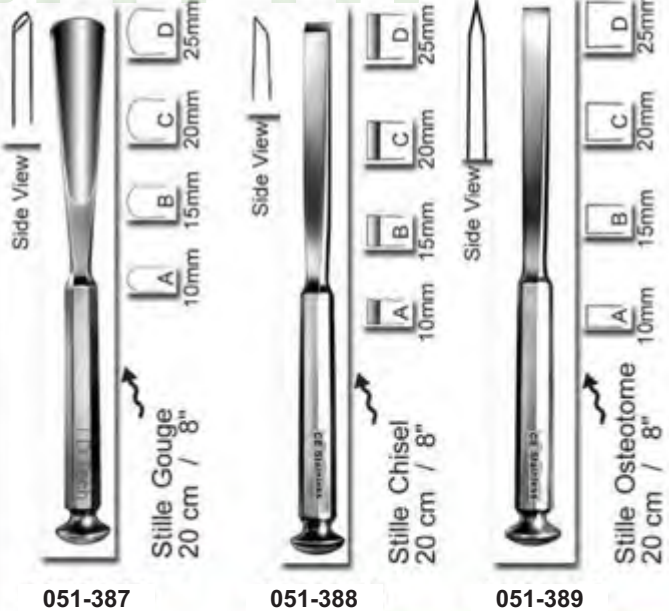

051-387
Stille Gouge
20 cm / 8"

051-388
Stille Chisel
20 cm / 8"

051-389
Stille Osteotome
20 cm / 8"

CHISELS- GOUGES- OSTEOTOMES

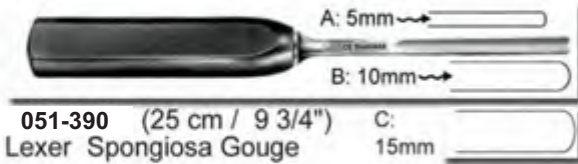

051-390 (25 cm / 9 3/4")
Lexer Spongiosa Gouge

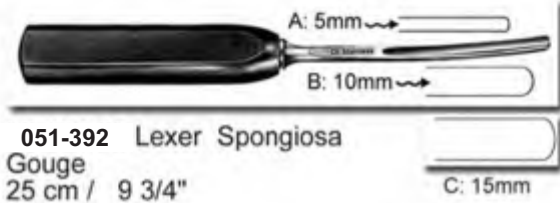

051-392 Lexer Spongiosa Gouge
25 cm / 9 3/4"

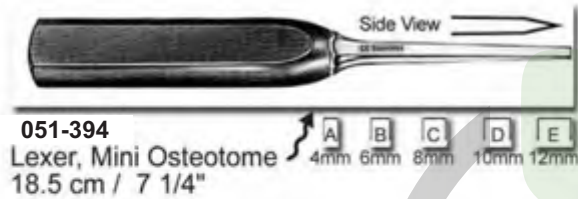

051-394 Lexer, Mini Osteotome
18.5 cm / 7 1/4"

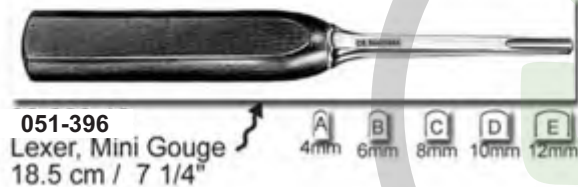

051-396 Lexer, Mini Gouge
18.5 cm / 7 1/4"

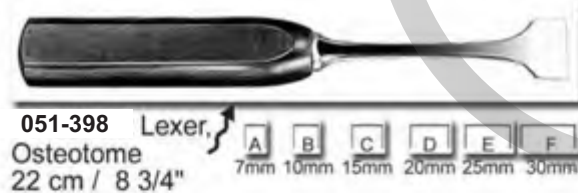

051-398 Lexer, Osteotome
22 cm / 8 3/4"

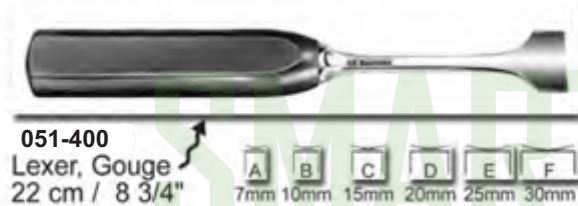

051-400 Lexer, Gouge
22 cm / 8 3/4"



051-402 Vickers Spongiosa Gouge
18 cm / 7"



051-404 US Army Chisel 18 cm / 7"

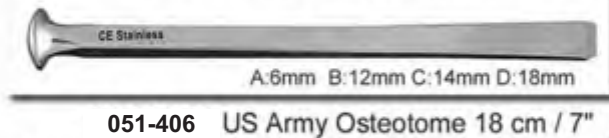

051-406 US Army Osteotome 18 cm / 7"

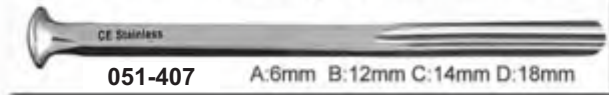

051-407 A:6mm B:12mm C:14mm D:18mm



051-391 Smith-Petersen Osteotome
20.5 cm/8"

Available Tips
6mm
9mm
13mm
16mm
19mm
25mm
32mm

TIP

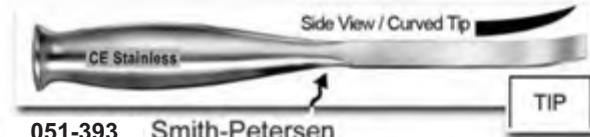

051-393 Smith-Petersen Osteotome
20.5 cm / 8"

6mm / 9mm / 13mm / 16mm / 19mm / 25mm / 32mm

TIP



051-395 Smith-Petersen Gouge
20.5 cm / 8"

TIP



051-397 Smith-Petersen Gouge
20.5 cm / 8"

TIP

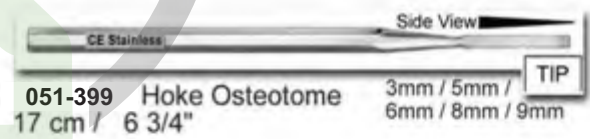

051-399 Hoke Osteotome
17 cm / 6 3/4"

TIP



051-389 Hibbs Osteotome
24.5 cm / 9 3/4"

6mm / 13mm / 19mm / 25mm / 32mm

TIP



051-401 Hibbs Chisel
24.5 cm / 9 3/4"

6mm / 13mm / 19mm / 25mm / 32mm

TIP



051-403 Hibbs Gouge
24.5 cm / 9 3/4"

6mm / 13mm / 19mm / 25mm / 32mm

TIP

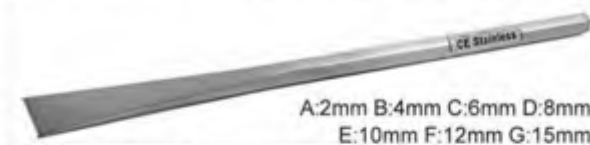

051-405 Sheehan Osteotome 16cm / 6 1/2"



051-408 Sheehan Osteotome 16cm / 6 1/2"

CHISELS- GOUGES- OSTEOTOMES

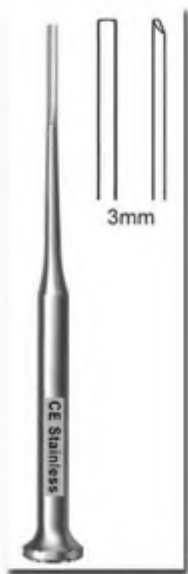

051-409
Shoulder Penetrating
Gouge 21cm/8 1/2"



051-410
Swan Neck
Gouge 23cm/9"

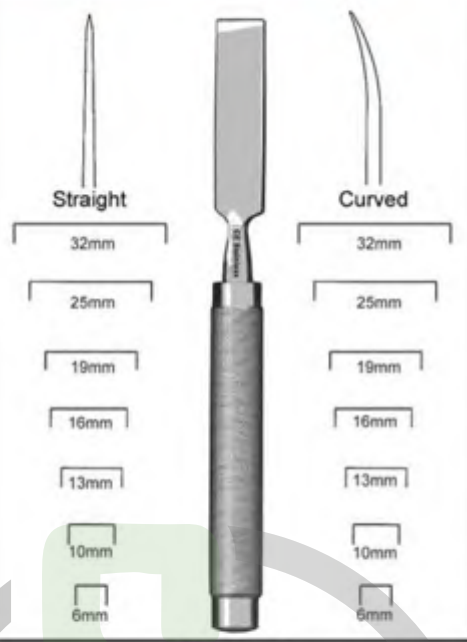

051-411
Cobb Osteotome 28cm/11"

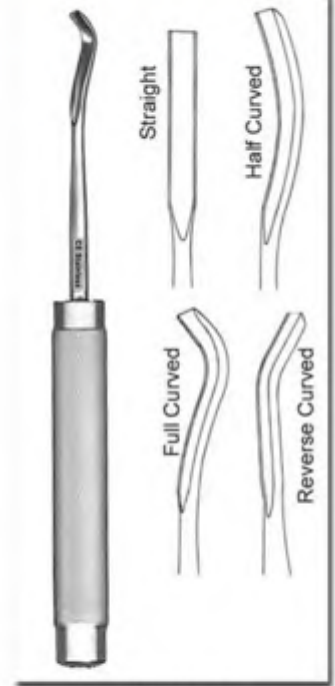

051-412
Cobb Gouge 28cm/11"

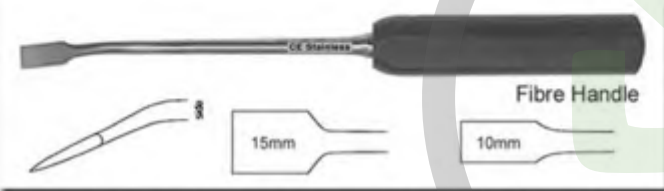

051-413 Lexer Osteotome Angled / 28cm/11"

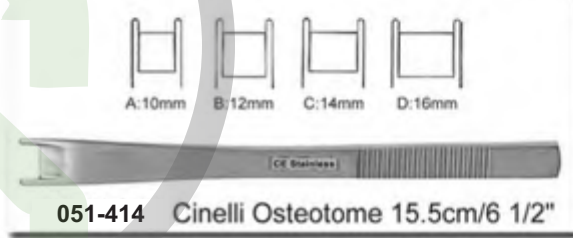

051-414 Cinelli Osteotome 15.5cm/6 1/2"

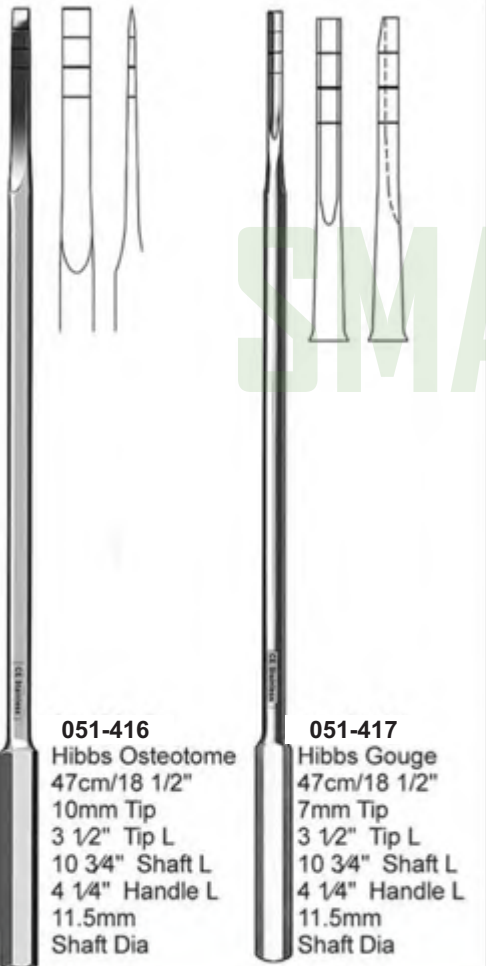

051-416
Hibbs Osteotome
47cm/18 1/2"
10mm Tip
3 1/2" Tip L
10 3/4" Shaft L
4 1/4" Handle L
11.5mm
Shaft Dia

051-417
Hibbs Gouge
47cm/18 1/2"
7mm Tip
3 1/2" Tip L
10 3/4" Shaft L
4 1/4" Handle L
11.5mm
Shaft Dia



051-418
Spinal Fusion
Gouge
24cm/9 1/2"
6mm Tip



051-415
Anderson Neivert Osteotome
20cm/8"

Set Includes:
5 Chisels
5/10/15/25mm
5 Osteotomes
5/10/15/25mm
3 Gouges
50/60/70mm Radius
1 Handle Fibre
1 Key

051-419
Chisel Handle Fibre w/Chisel - Osteotome - Gouge Blades
18.5cm/7 1/4"

BONE CURETTES



051-420 (18.5 cm / 7 1/4")
Volkman Bone Curette
 oval with plastic handle



051-422 A / B / C
Volkman Bone Curette,
 double-ended (oval / round).

Available in 3 sizes (Length)
 A: 13 cm / 5"
 B: 16 cm / 6 1/4"
 C: 20 cm / 8"



051-424 Bone Curette,
 double-ended (round / oval) 21 cm / 8 1/4"



051-426 Schede Bone Curette
 17 cm / 6 3/4" oval with hollow handle



051-429 Volkman Bone Curette
 17 cm / 6 3/4" oval, with hollow handle



051-431 Bruns Bone Curette
 17 cm / 6 3/4" Round, with hollow handle



051-433
Spratt Bone Curette
 17 cm / 6 3/4"
 Oval, with hollow handle

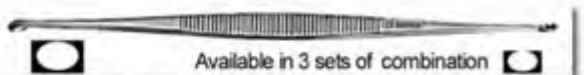

051-435 A / B / C
Williger Bone Curette,
 double-ended 13.5 cm / 5 1/4"

Available in 3 sets of combination
 A: 00/0 ●/●
 B: 0/1 ●/●
 C: 1/2 ●/●



051-437 A / B / C Williger
Bone Curette, 17 cm / 6 3/4"
 double-ended oval / oval

A: 00/0 ●/●
 B: 0/0 ●/●
 C: 1/1 ●/●

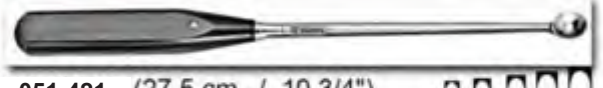

051-421 (27.5 cm / 10 3/4")
Volkman Bone Curette
 oval with plastic handle



051-423 Bruns Bone Curette
 23 cm / 9" oval, solid



051-425 A / B / C
Scoville Bone Curette
 25 cm / 9 3/4"
 oval, with hollow handle



051-427 Simon Bone Curette
 25 cm / 9 3/4"
 oval, with hollow handle



051-430 Modell USA
Bone Curette 16 cm / 6 1/4"
 Oval, with hollow handle



051-432 Modell USA
Bone Curette 15.5 cm / 6 "
 Oval, with hollow handle



051-434 Modell USA
Bone Curette 15.5 cm / 6 "
 Oval, with hollow handle



051-436 Halle Bone Curette
 21 cm / 8 1/4" oval, malleable shaft,
 with hollow handle

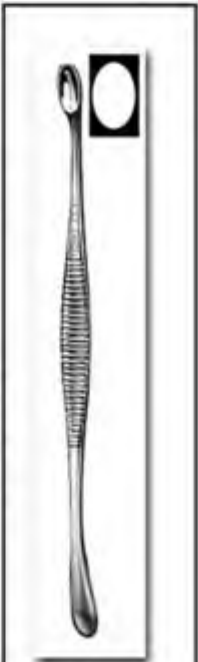

051-428 A / B / C
**Volkman
 Bone Curette**,
 double-ended

Available in 3 sizes
 (Length)
 A: 12.5 cm / 5"
 B: 14.5 cm / 5 3/4"
 C: 17 cm / 6 3/4"

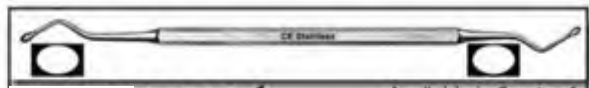

051-438 A / B / C
**Hemingway-Martin
 Bone Curette**, double-ended
 18.5 cm / 7 1/4"
 octagonal handle oval / oval

Available in 3 sets of
 same order faces
 A: 1 R/L ●/●
 B: 2 R/L ●/●
 C: 3 R/L ●/●

For 18cm: **051-439** A / B / C (3 same order sets)
Hemingway Bone Curette, double-ended 18 cm/7"
 octagonal handle oval / oval (For illustration see 12-374-18)

BONE CURETTES

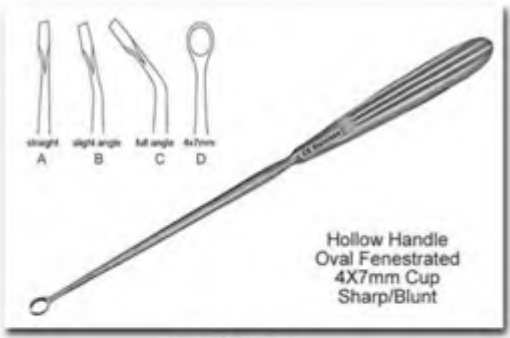
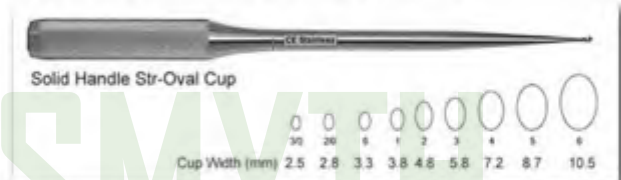
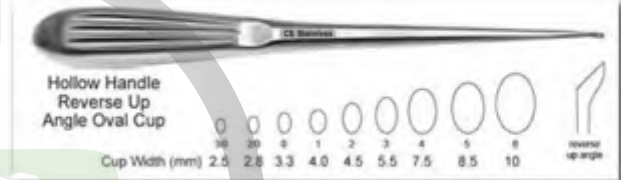
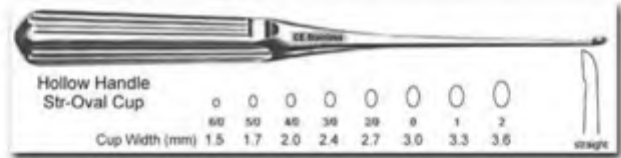
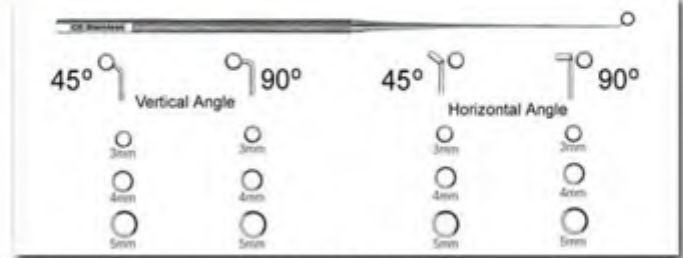
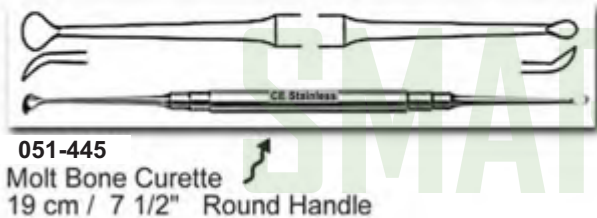
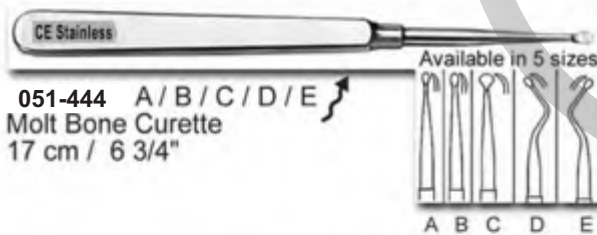
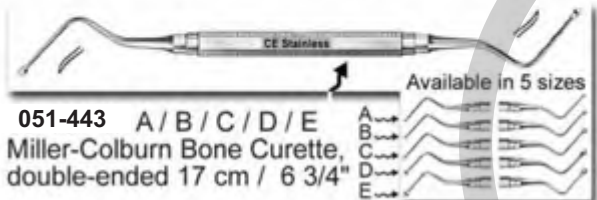
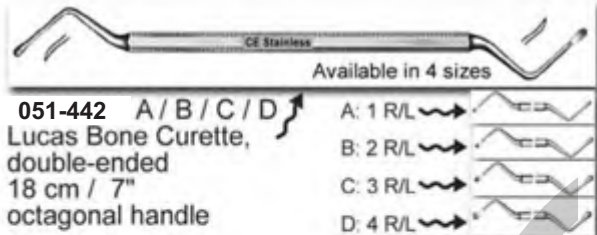
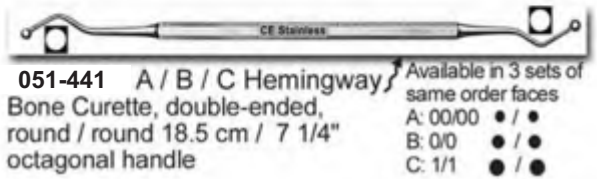
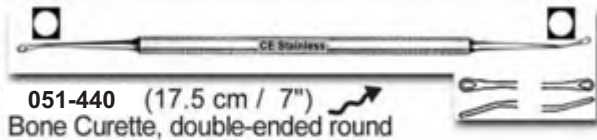

- A: 25 cm / 10" #0 6mm Cup
- B: 25 cm / 10" #2 8mm Cup
- C: 26 cm / 10 1/2" #6 14mm Cup
- D: 28 cm / 11 1/2" #0 6mm Cup
- E: 28 cm / 11 1/2" #2 8mm Cup
- F: 30 cm / 12 1/2" #6 14mm Cup

BONE CURETTES

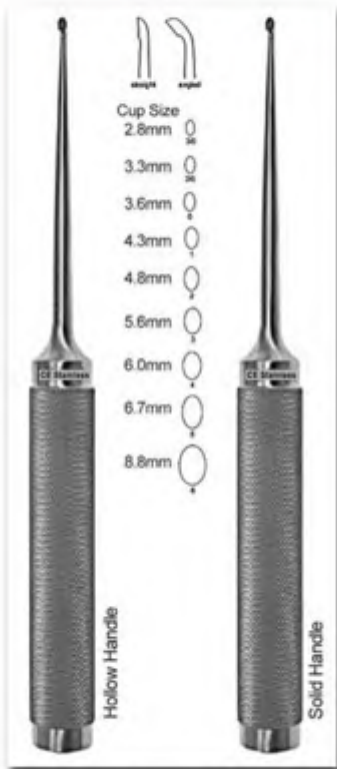

051-454
Cobb Curette Oval Cups
28 cm / 11"



051-455
Cobb Curette Oval Cups
28 cm / 11"



051-456
Sypert Curette Long Delicate Shaft



051-457
Cone Ring Curette
23 cm / 9"



- A: Straight 8mm Sharp/Blunt
- B: Straight 11mm Sharp/Blunt
- C: Angled 8mm Sharp/Sharp
- D: Angled 11mm Sharp/Sharp
- E: Angled 8mm Sharp/Sharp Right Cvd
- F: Angled 11mm Sharp/Sharp Right Cvd
- G: Angled 8mm Sharp/Sharp Left Cvd
- H: Angled 11mm Sharp/Sharp Left Cvd

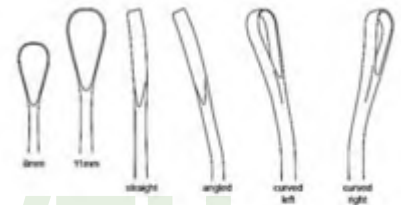

051-458 Zielke Ring Curette 34 cm / 13 1/2" TEFLON Handle

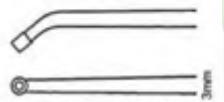

17° Angled 40°
3mm Diameter
2.7" Tip Length
9.3" Shaft Length
5" Handle Length
.285 (7.2mm)
Shaft Diameter



051-459 Cone Ring Curette Endoscopic Fibre Handle

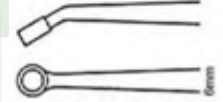

20° Angled 30°
6mm Diameter
3 1/2" Tip Length
10" Shaft Length
6 1/2" Handle Length
.45" (11.5mm)
Shaft Diameter

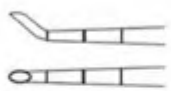

17° Reverse
Angled 40°
3mm x 6mm cup
2.7" Tip Length
9.3" Shaft Length
5" Handle Length
.285 (7.2mm)
Shaft Diameter



051-460 Epstein Curette Endoscopic Fibre Handle

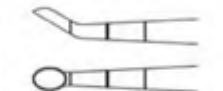

20° Reverse
Angled 30°
6mm x 9mm cup
3 1/2" Tip Length
10" Shaft Length
6 1/2" Handle Length
.45 (7.2mm)
Shaft Diameter

ELEVATORS

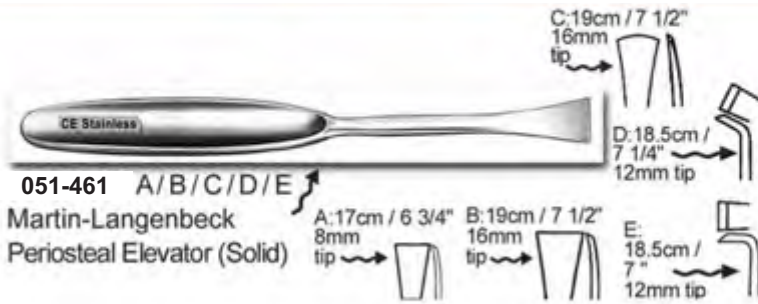

051-461 A/B/C/D/E
Martin-Langenbeck Periosteal Elevator (Solid)

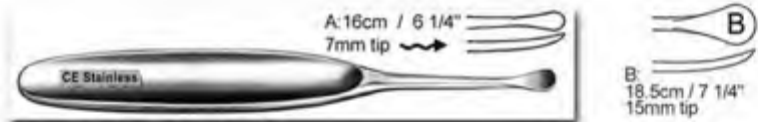

051-463 A/B/C
Martin-Langenbeck Periosteal Elevator (Solid)



051-465 A/B/C/D
Martin-Langenbeck Periosteal Elevator (Solid)



051-468 Langenbeck Periosteal Elevator 18.5 cm / 7 1/4" with hollow handle

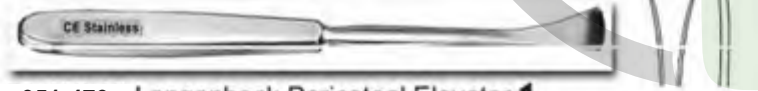

051-470 Langenbeck Periosteal Elevator 19.5 cm / 7 3/4" with hollow handle

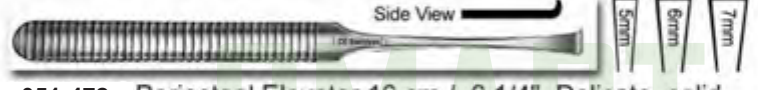

051-472 Periosteal Elevator 16 cm / 6 1/4" Delicate, solid



051-474 Farabeuf Periosteal Elevator 15 cm / 6" with hollow handle



051-476 Periosteal Elevator 3mm Tip 18 cm / 7" extra narrow, with plastic handle



051-478 A/B Kahre-Williger Periosteal Elevator solid

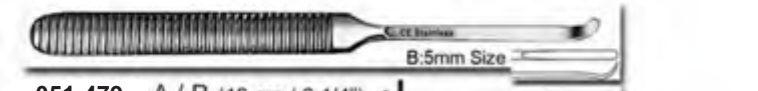

051-479 A/B (16 cm / 6 1/4") Kahre-Williger Periosteal Elevator solid

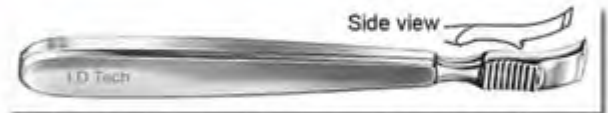

051-462 Farabeuf Periosteal Elevator 15 cm / 6" with hollow handle



051-464 (15mm Tip) Sedillot Periosteal Elevator 22 cm / 8 3/4"



051-466 Periosteal Elevator 20 cm / 8" (14 mm Tip) with plastic handle



051-467 Periosteal Elevator 19 cm / 7 1/2" (14mm Tip) with plastic handle



051-469 Periosteal Elevator 6mm Tip 18 cm / 7" narrow, con plastic handle



051-471 Periosteal Elevator 18 cm / 7" narrow, con plastic handle (6mm Tip)

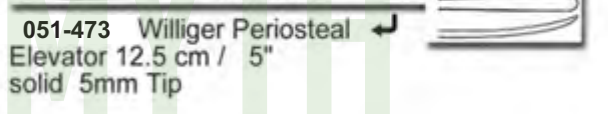

051-473 Williger Periosteal Elevator 12.5 cm / 5" solid 5mm Tip

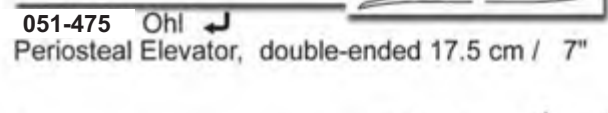

051-475 Ohl Periosteal Elevator, double-ended 17.5 cm / 7"



051-477 A/B/C/D/E Semb Periosteal Elevator
A+D: 21cm / 8 1/4" & B+C: 18.5 cm / 7 1/4"
A: V-shape 12mm B: Inside round 12mm
C: Straight 13mm D: Outer round 15mm

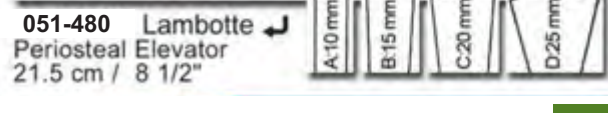

051-480 Lambotte Periosteal Elevator 21.5 cm / 8 1/2"

ELEVATORS



051-481 Periosteal Elevator
20 cm / 8" with plastic handle



051-483 A / B Periosteal Elevator
17 cm / 6 3/4" with hollow handle

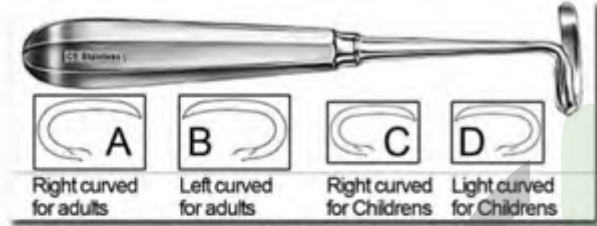

051-485 A / B / C / D Doyen Rib Raspatory
17.5 cm / 7" Rib Raspatories with hollow handle



051-487 West Periosteal Elevator,
double-ended 18.5 cm / 7 1/4"
octagonal handle

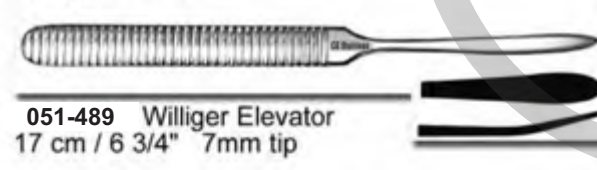

051-489 Williger Elevator
17 cm / 6 3/4" 7mm tip



051-491 Williger Elevator
16 cm / 6 1/4" (5.5mm tip)



051-493 Elevator
17 cm / 6 3/4" Light weight

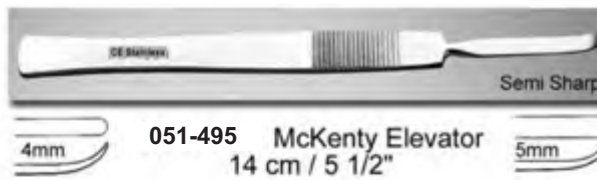

051-495 McKenty Elevator
14 cm / 5 1/2"

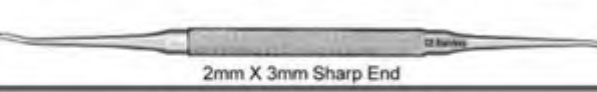

051-497 Kleinert Kutz
Elevator 14 cm / 5 1/2"



051-499 Penfield Elevator Endoscopic
38 cm / 15" 5mm Semi Sharp / 1X10mm Blunt Hook

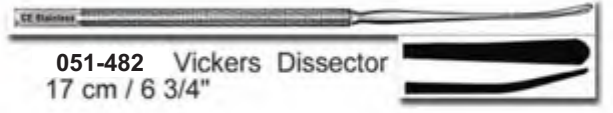

051-482 Vickers Dissector
17 cm / 6 3/4"

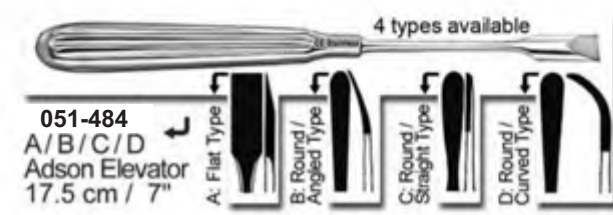

051-484 A/B/C/D Adson Elevator
17.5 cm / 7"

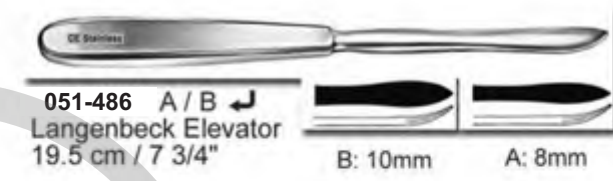

051-486 A / B Langenbeck Elevator
19.5 cm / 7 3/4"



051-488 A/B/C/D Martin Langenbeck Elevator
17 cm / 6 3/4" except D

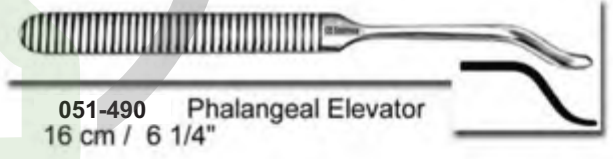

051-490 Phalangeal Elevator
16 cm / 6 1/4"

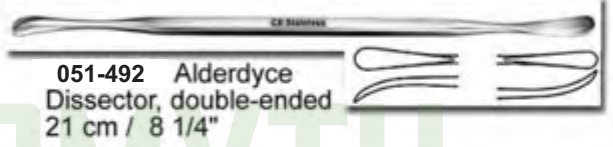

051-492 Alderdyce Dissector, double-ended
21 cm / 8 1/4"

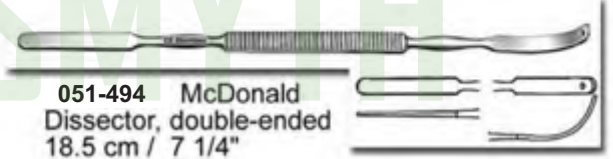

051-494 McDonald Dissector, double-ended
18.5 cm / 7 1/4"

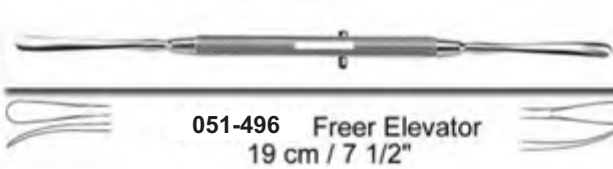

051-496 Freer Elevator
19 cm / 7 1/2"



051-498 Smithwick Hook and Dissector
30 cm / 12" 5mm Semi Sharp / 1X10mm Blunt Hook

ELEVATORS

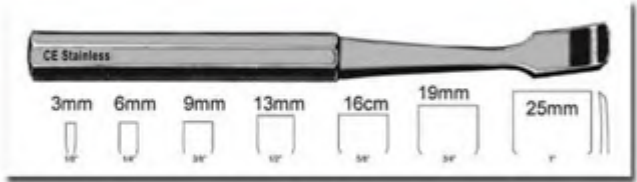

051-501 Key Elevator 19 cm / 7 1/2" Sharp Edge



051-502 Sayre Elevator 16 cm / 6 1/2"
A: Sharp / Blunt B: Blunt/ Blunt



051-503 Sedilot Elevator 18 cm / 7" Sharp Edge



051-504 Kirmission Periosteal Respiratory 17 cm / 6 3/4"



051-505 Alexander Periosteal Respiratory 20 cm / 8" / 12mm Sharp



051-506 Periosteal Elevator 17 cm / 6 3/4"
Fibre Handle 13mm Blade Sharp

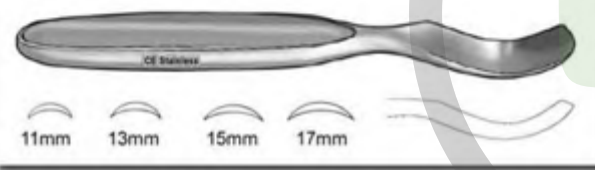

051-507 McGlamry Metatarsal Elevator 16 cm / 6 1/2" Sharp



051-508 Crego Periosteal Elevator 19 cm / 7 3/4" Sharp
A: 14mm Full Curves B: 14mm Slight Curves
C: 7mm Full Curves D: 7mm Slight Curves



051-509 Chandler Elevator Blunt

A: 19cm / 7 1/2" 13mm B: 20cm / 8" 19mm
C: 23cm / 9" 25mm D: 25.5cm / 10" 30mm

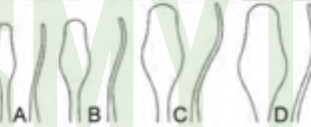

051-510 Darrach Elevator Blunt

Small
A: 26cm / 10 1/4" 13mm Width at Tip
Medium
B: 26cm / 10 1/4" 20mm Width at Tip
Large
C: 35cm / 13 3/4" 25mm Width at Tip

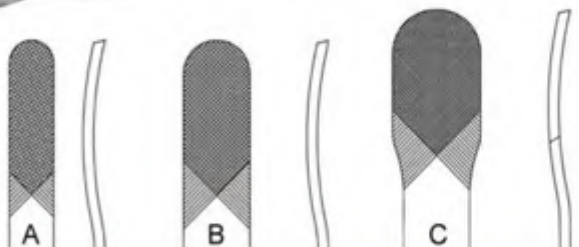

ELEVATORS

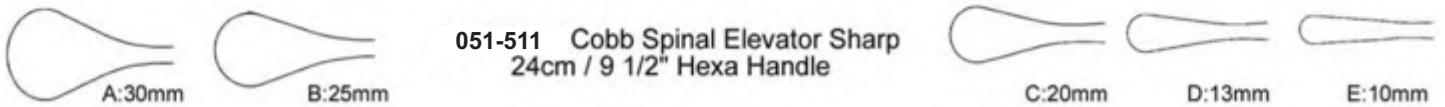

051-511 Cobb Spinal Elevator Sharp
24cm / 9 1/2" Hexa Handle



Also Available
in Fibre Handle

with Same
Sizes
of Blades

051-512
25cm / 10"

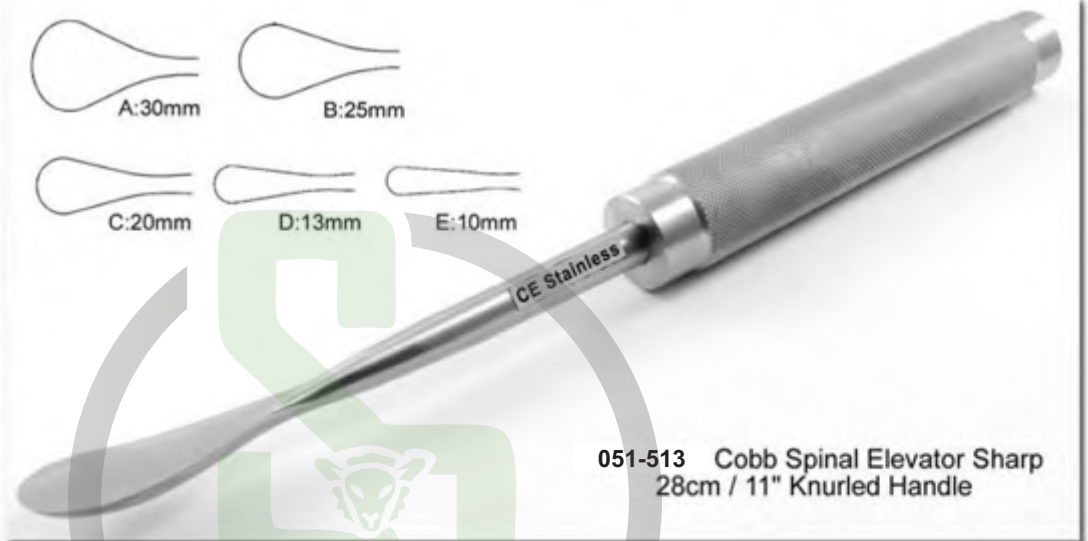
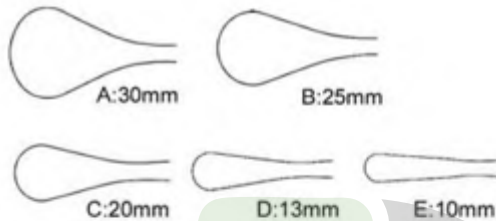

051-513 Cobb Spinal Elevator Sharp
28cm / 11" Knurled Handle



051-514 Cobb Elevator Endoscopic Sharp / Fibre Handle



051-515 Rib Elevator Endoscopic Sharp / Fibre Handle
43cm / 17" - 9mm Tip Radius - 4" Tip Length
8" Shaft Length - 5" Handle Length
11.5mm Shaft Dia

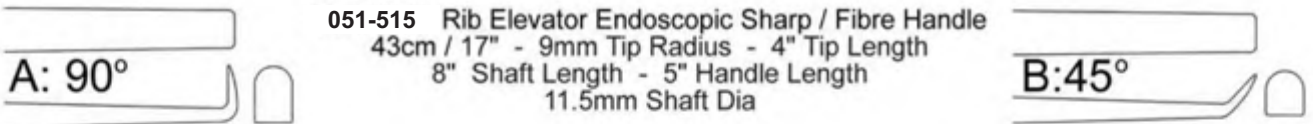

051-516 Wagner Elevator Sharp / Fibre Handle
33cm / 13"
A: 8mm Wide B: 17mm Wide

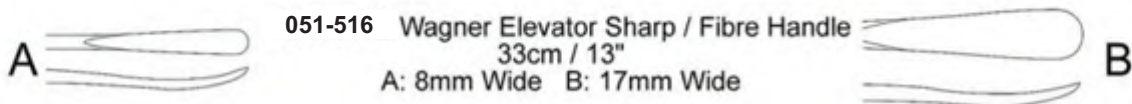

BONE MALLETS

Note: Handle Shown In Dark Colors are Made of FIBRE Material

052-101 Lucae Mallet 19.5cm / 7 3/4"



052-103 Cottle Mallet Plane / Convex



052-105 Williger Mallet

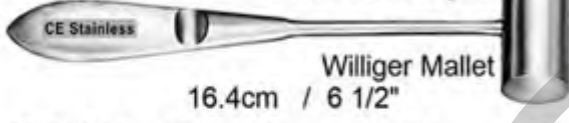

052-108 Mallet 26 cm / 10 1/4"



052-110 Mead Mallet
19 cm / 7 1/2"



052-112 Partsch Mallet



052-115 Mallet 26 cm / 10 1/4"
with lead filling



052-116 Mallet
26 cm / 10 1/4"



052-118 Williger Mallet

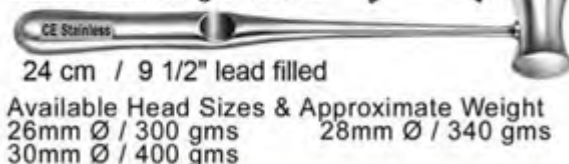

052-102 Mallet 30mm Ø / 675 gms
26.5 cm / 10 1/2"



052-104 Mallet 26 cm / 10 1/4"



052-106 Mallet 24 cm / 9 1/2"

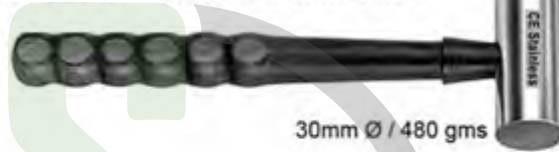

052-109 Mallet 24 cm / 9 1/2"
Disks and handle of



052-111 30mm Ø / 125 gms



052-113 Mallet 26.5 cm / 10 1/2"



052-117 A/B/C Doyen Mallet



052-119 Herbert Mallet
19 cm / 7 1/2"



BONE MALLETS

Note: Handle Shown In Dark Colors are Made of FIBRE Material



052-121
Kirk Mallet 20cm / 8"
Head Dia 38mm/Weight: 1 lb. 4 oz. (570 grams)



Head Weight: 7 oz (200 grams)

052-122 Gerzog Mallet 19cm / 7 1/2"
Head Dia 25mm/Weight 10 oz (285 grams)



Head Weight: 20 oz (567 grams)

052-123 Heath Mallet
19cm / 7 1/2"
Head Dia 40mm/Weight 2 lbs. (907gm)

Head Weight: 20 oz (567 grams)



052-126 Heath Mallet, SS
18cm / 7" Solid Frame Handle
Head Dia 40mm/Weight 36 oz. (1020gm)



052-128 All Fibre Mallet 24cm / 9 1/2"
Head Dia 80X60mm Weight 14oz. (397gm)



Fibre Handle

052-124
Cloward Mallet
19cm / 7 1/2"
Head Dia 20mm
Weight 8oz. (227gm)



052-125
Hajek Mallet
20cm / 8"
Head Dia 27mm
Weight 7oz. (198gm)

Fibre Handle



052-127 Narrow Tip Mallet 20cm / 8"
Head Dia 7mm Weight 6oz. (170gm)



052-129 Fibre Handle Mallet 23cm / 9"
Head Dia 30mm/Weight 12 oz. (340gm)
Also Available in:
Head Dia 35mm/Weight 1lb 40 oz. (570gm)
Head Dia 40mm/Weight 1lb 90 oz. (708gm)



052-130 He-Man Mallet 28cm / 11"
Head Dia 38mm / 24mm
Weight 2lb (906gm)

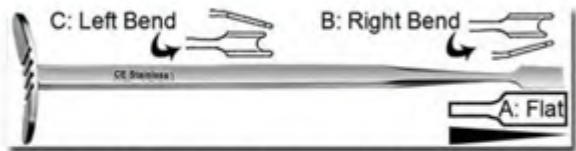

052-131 Smillie Meniscus Knife 18 cm / 7"



052-132 Meniscus Knife 18 cm / 7"

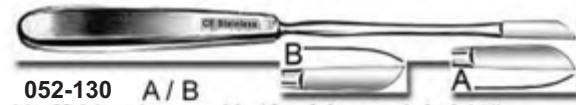

052-130 A / B
Neff Meniscus Knife 22 cm / 8 3/4"



052-133 A / B Salenius Meniscus Knife
21 cm / 8 1/4" A: Right / B: Left



052-134 Bunnell Tendon Stripper 15 cm / 6"
3mm 4mm 5mm 6mm 7mm



052-135
Tendon Stripper
23 cm / 9"
Flexible shaft



052-136 Tendon Passing Instrument 33.5 cm / 13 1/4"



052-137 Fischer Tendon Stripper 31 cm / 12 1/4" Blunt



052-138 Tendon Stripper 3 / 4 / 5 / 6mm
A: 28.5 cm / 11 1/4" B: 60 cm / 24"

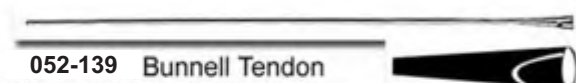

052-139 Bunnell Tendon Passer 23 cm / 9" Malleable



052-140 Tendon Stripper 40 cm / 16"
Fibre Handle



052-141
Lowe Breck
Cartilage Knife
25 cm / 10"
Str Edge-Cvd Blade
w/ Guards

052-142
Downing
Cartilage Knife
25 cm / 10"
Concave Edge
Cvd Blade
w/ Guards



052-143 Martin Cartilage Scissors 20cm / 8"

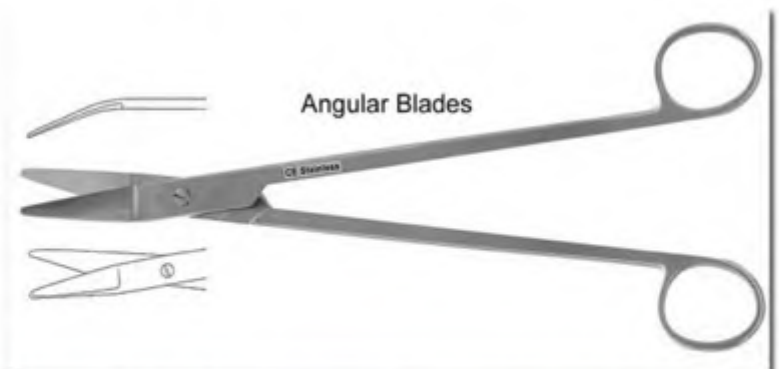

052-144 Mueller Capsule Scissors 24cm / 9 1/2"

TENDON INSTRUMENTS

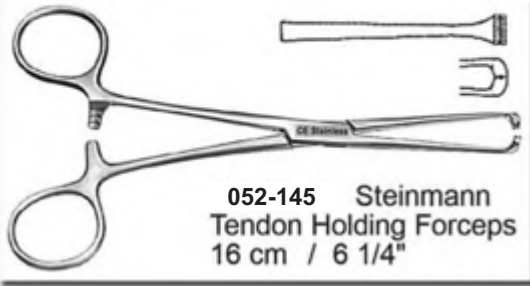

052-145 Steinmann Tendon Holding Forceps
16 cm / 6 1/4"

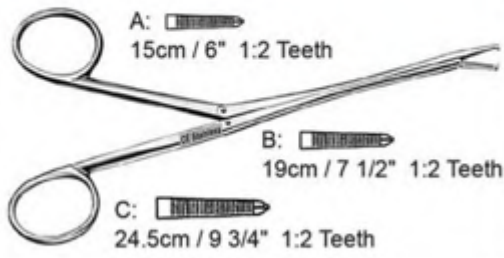

052-146 A / B / C Brand Tendon Tunnelling Forceps

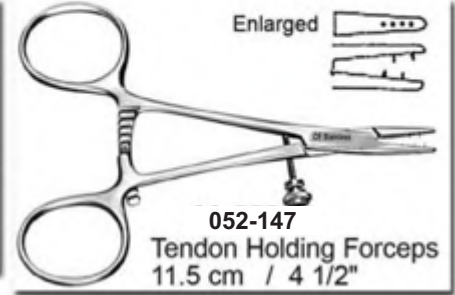

052-147 Tendon Holding Forceps
11.5 cm / 4 1/2"

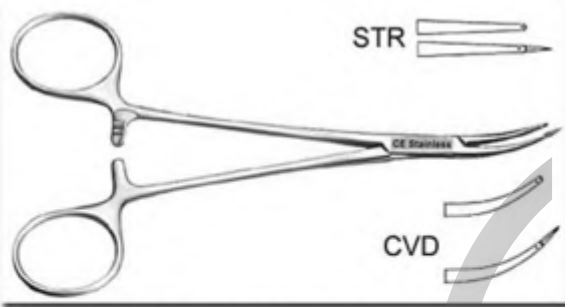

052-148 Tendon Interlacing Forceps
15.5 cm / 6" Pointed



052-149 Carroll Tendon Holding Forceps 11.5 cm / 4 1/2"



052-150 Hallman Tendon Tunnelling Forceps
21 cm / 8 1/4"



052-151 Kleinert-Kutz Tendon Holding Forceps
21 cm / 8 1/4" 1X2 teeth



052-152 Hoen Grasping Forceps
14 cm / 5 1/2" (Shaft)
1X2 teeth



052-153
Meniscus Clamp
13.5 cm / 5 3/8" 1X2 teeth

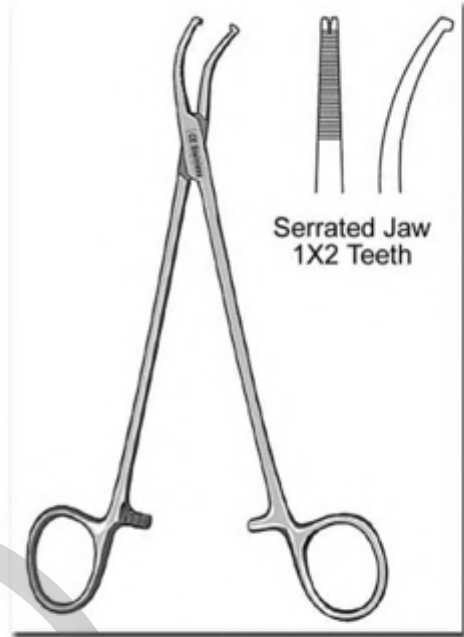

052-154
Preston Ligamentum Flavum Forceps
(Meniscus) 18.5 cm / 7 1/4"



Straight



Angled

052-155
Ortho Grasper 21 cm / 8 1/2"
7 X 20 MM Bite

PELVIC REDUCTION INSTRUMENTS

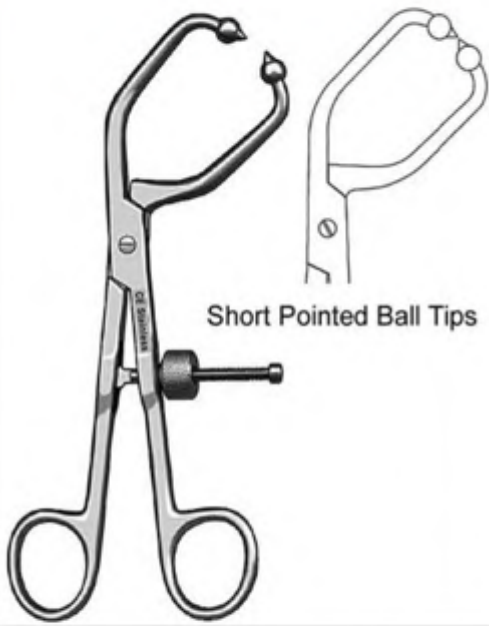

Short Pointed Ball Tips

052-156 Pelvic Reduction Forceps
19 cm / 7 3/8" Angular

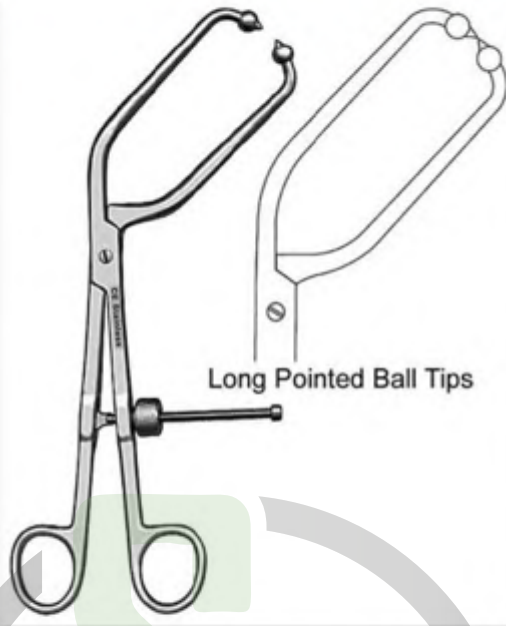

Long Pointed Ball Tips

052-157 Pelvic Reduction Forceps
24.5 cm / 9 5/8" Angular

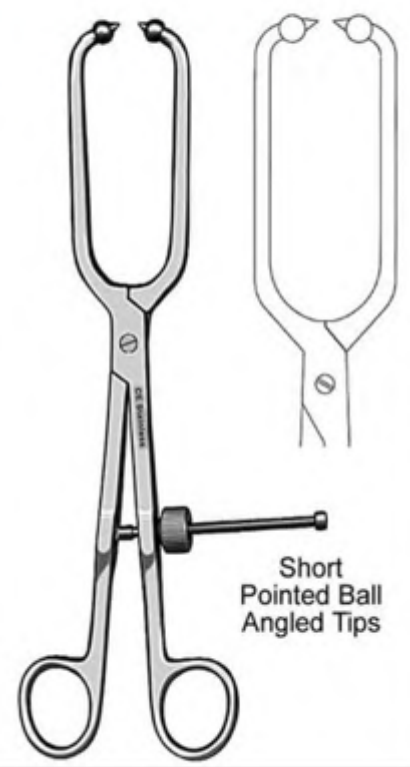

Short Pointed Ball Angled Tips

052-158
Pelvic Reduction Forceps
25 cm / 10"

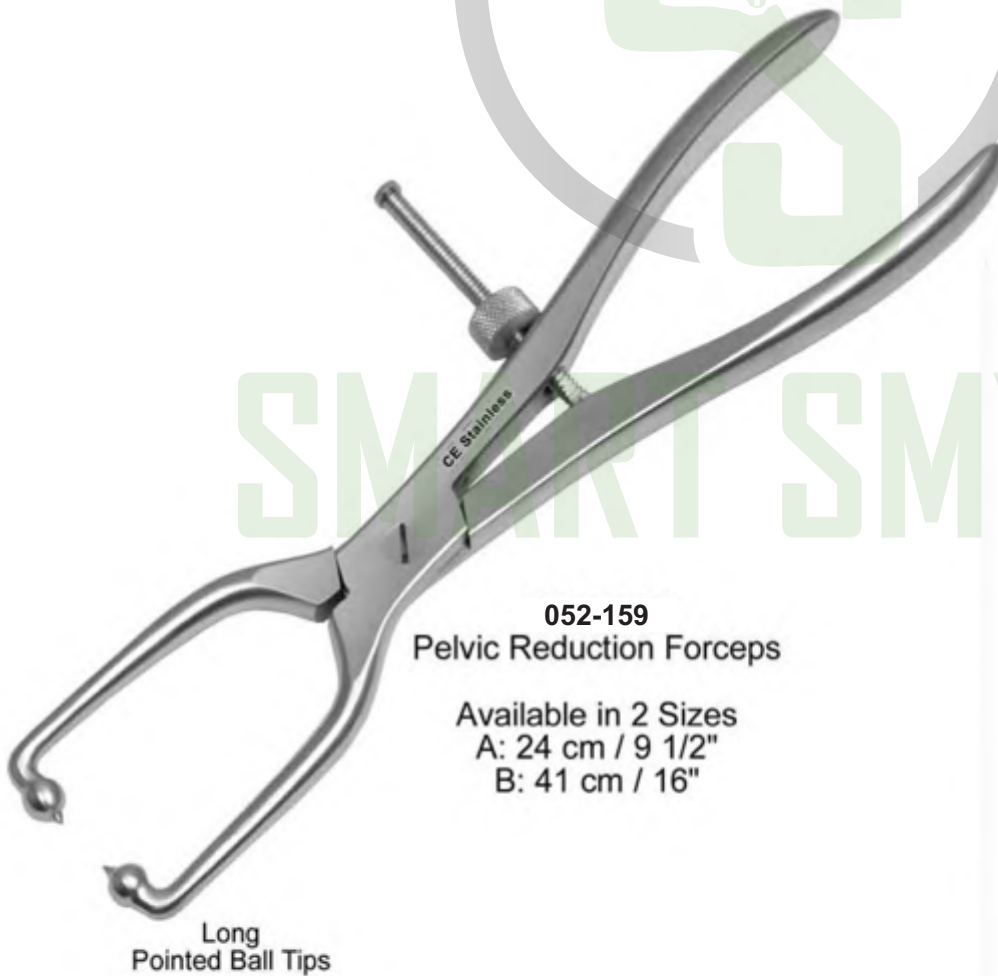

052-159
Pelvic Reduction Forceps

Available in 2 Sizes
A: 24 cm / 9 1/2"
B: 41 cm / 16"

Long Pointed Ball Tips

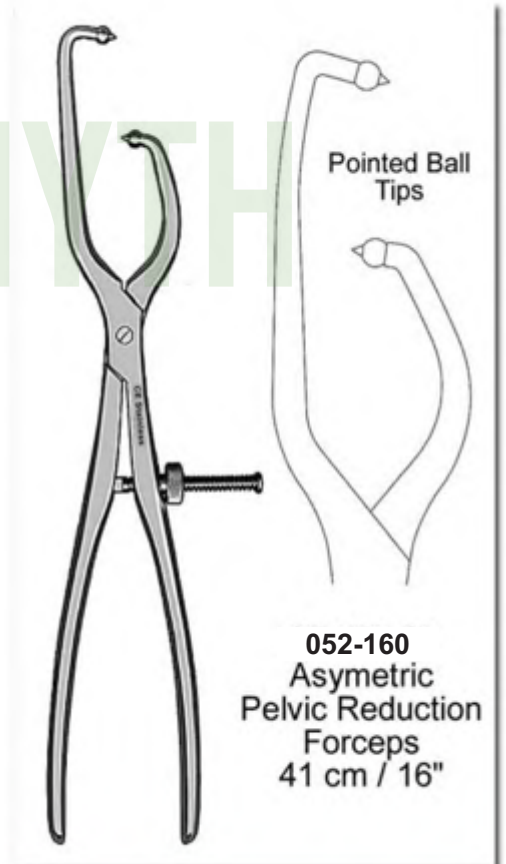

Pointed Ball Tips

052-160
Asymmetric Pelvic Reduction
Forceps
41 cm / 16"



052-161
Pelvic Reduction Forceps
Long 1X2
Pointed Ball Tips
41 cm / 16"

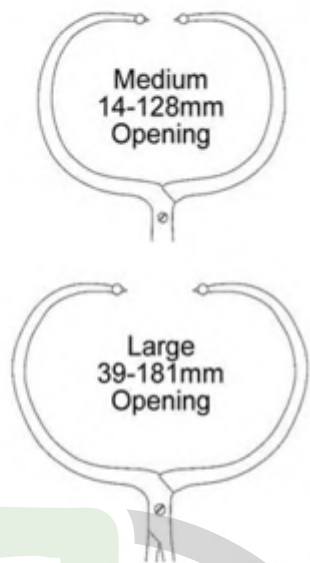

052-162
Periarticular
Reduction Forceps
Straight
Pointed Ball Tips
38 cm / 15"



052-163
Pelvic
Reduction Forceps
Adjustable Jaws for Screws
A: 25 cm / 10"
B: 33 cm / 13"

BONE HOLDING FORCEPS

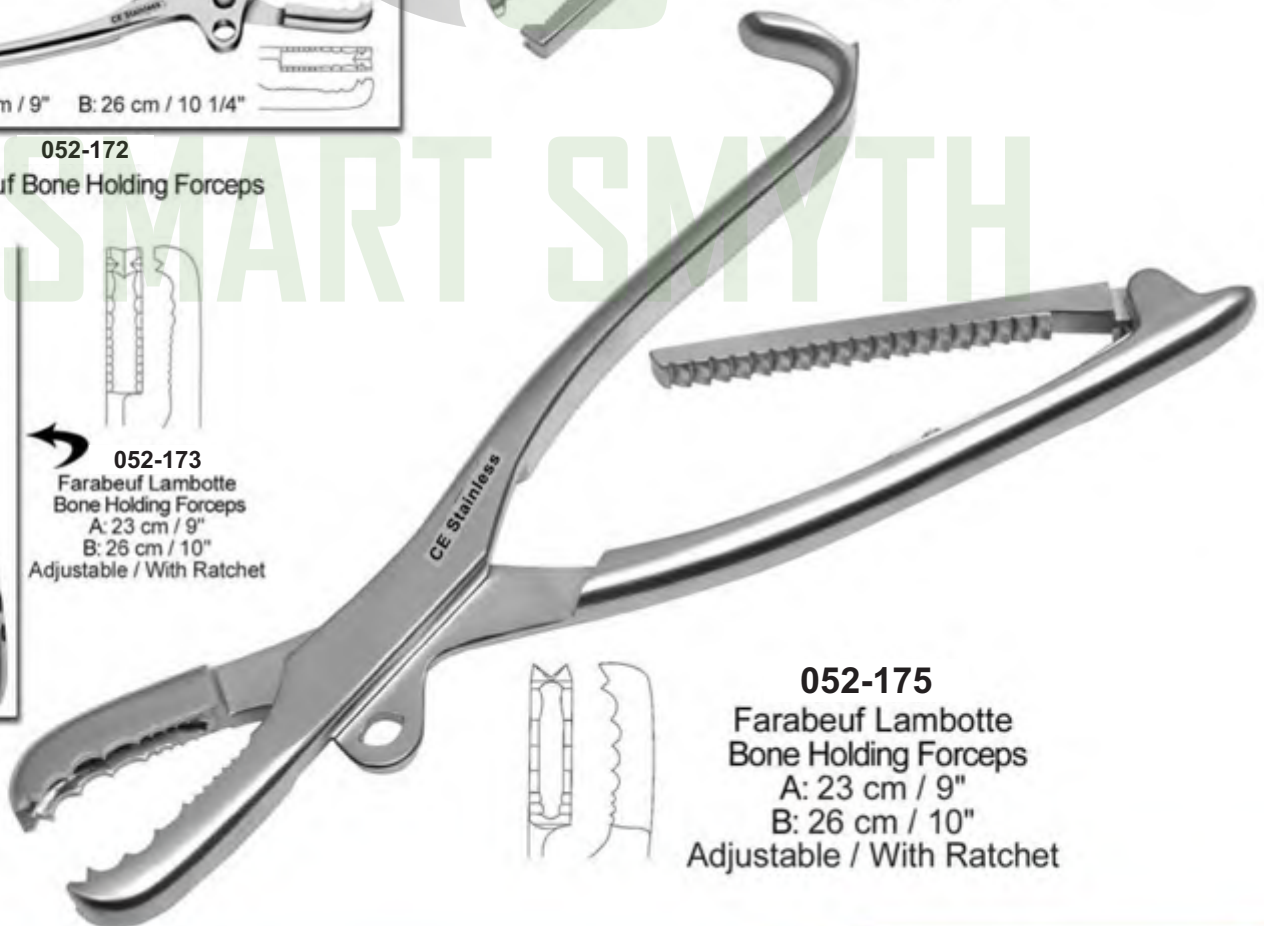
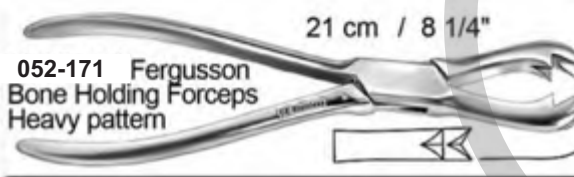
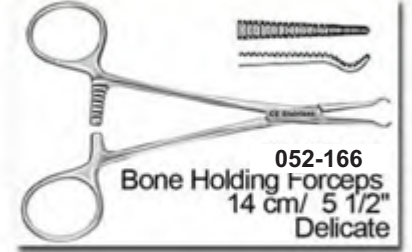

BONE HOLDING FORCEPS

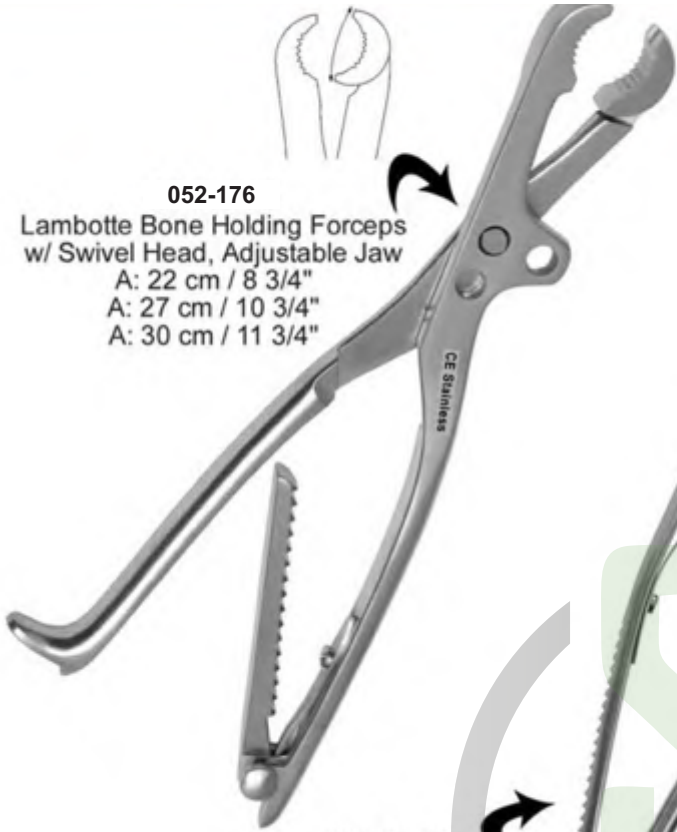

052-176
Lambotte Bone Holding Forceps
w/ Swivel Head, Adjustable Jaw
A: 22 cm / 8 3/4"
A: 27 cm / 10 3/4"
A: 30 cm / 11 3/4"



052-178
Ulrich Bone Holding Forceps
w/ Thread Fixation
A: 23 cm / 9"
A: 25 cm / 9 3/4"
A: 28 cm / 11"



052-177
Ulrich Bone Holding Forceps
w/ Thread Fixation
19 cm / 7 1/4"

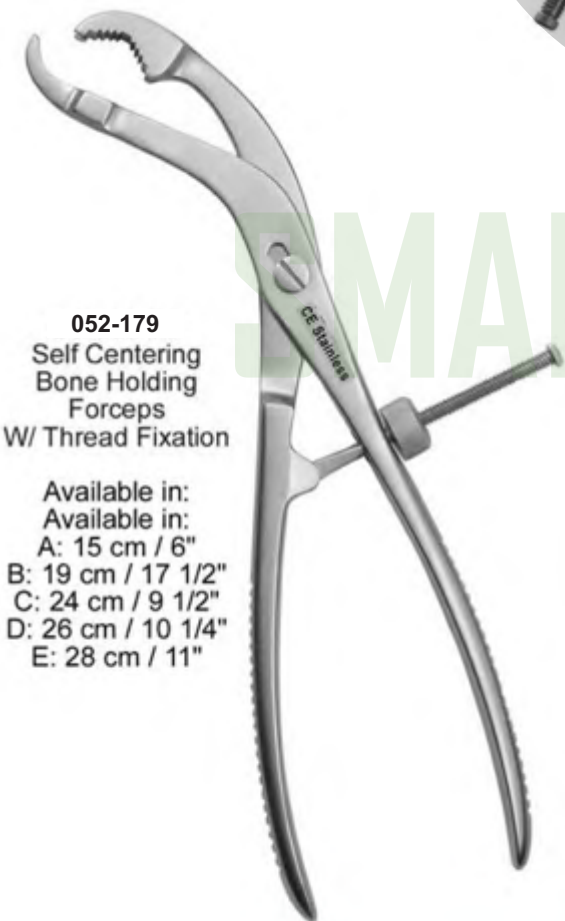

052-179
Self Centering
Bone Holding
Forceps
W/ Thread Fixation

- Available in:
- Available in:
- A: 15 cm / 6"
- B: 19 cm / 17 1/2"
- C: 24 cm / 9 1/2"
- D: 26 cm / 10 1/4"
- E: 28 cm / 11"

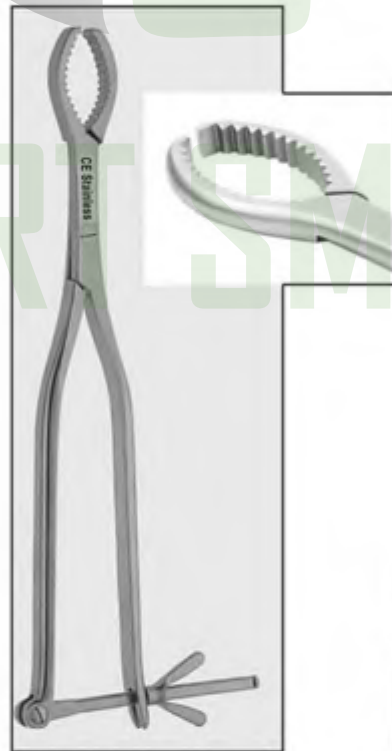

052-180
Hey Groves
Bone Holding Forceps
A: 20 cm / 8"
B: 25 cm / 10"
C: 30 cm / 12"



052-181 A
Lane Bone Holding Forceps
w/ Ratchet
A: 33 cm / 13"
B: 45 cm / 17 3/4"



052-181 B
without
Ratchet

BONE HOLDING FORCEPS

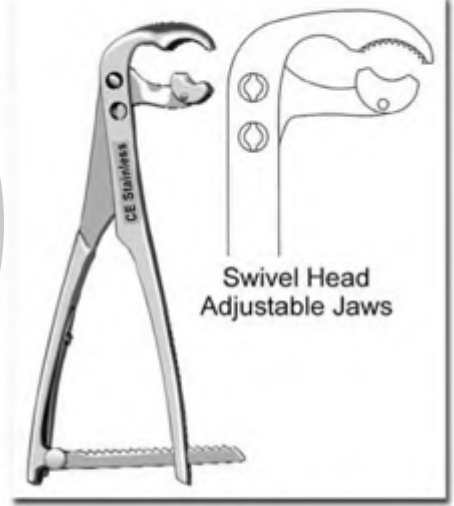
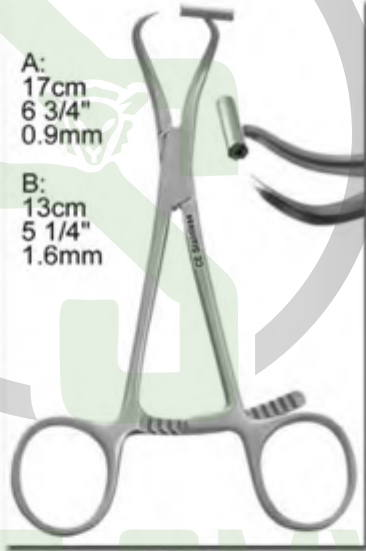
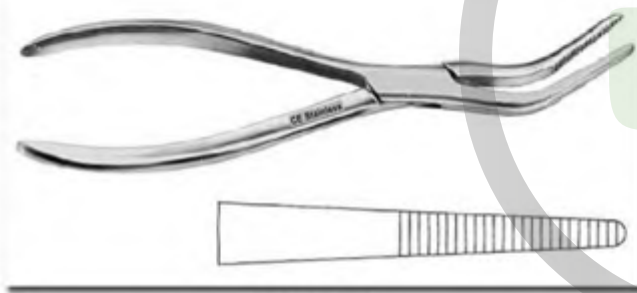

CARTILAGE - REPOSITION FORCEPS



052-190
Walton
Cartilage Seizing Forceps
20.5 cm / 8"
A: Straight
B: Upward Cvd
C: Sideward Cvd

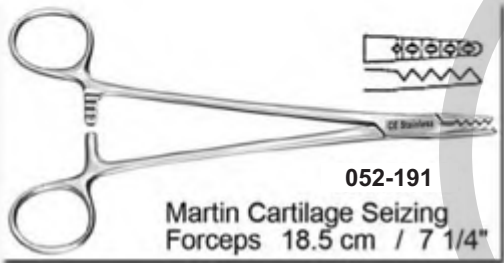
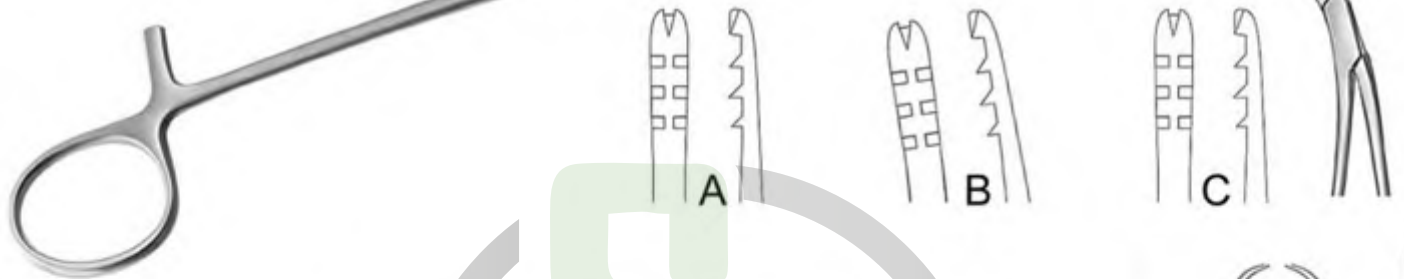

052-191
Martin Cartilage Seizing
Forceps 18.5 cm / 7 1/4"

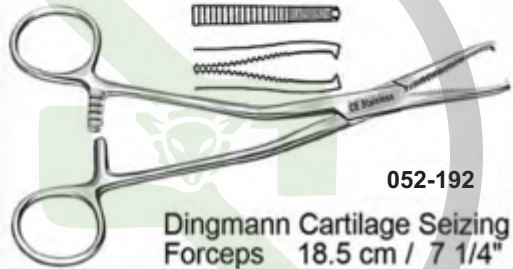

052-192
Dingmann Cartilage Seizing
Forceps 18.5 cm / 7 1/4"



052-193
Reposition Forceps
13.5 cm / 5 1/4"
Long ratchet pointed

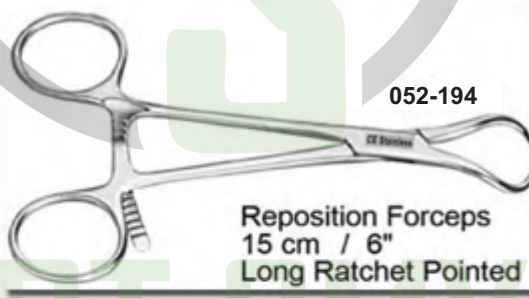

052-194
Reposition Forceps
15 cm / 6"
Long Ratchet Pointed

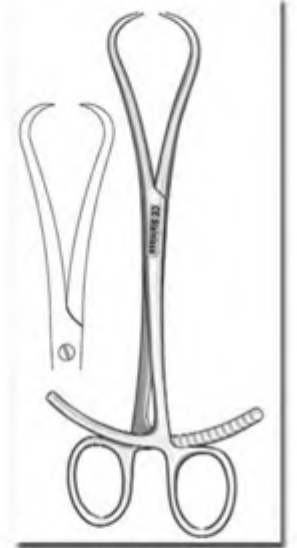

052-195
Walton Bone
Reduction Forceps
20.5 cm / 8"
2" Double Ratchet
Opening 9-100mm

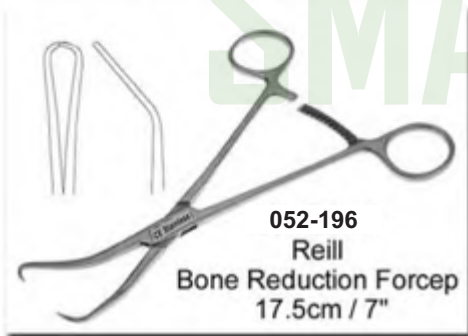

052-196
Reill
Bone Reduction Forcep
17.5cm / 7"

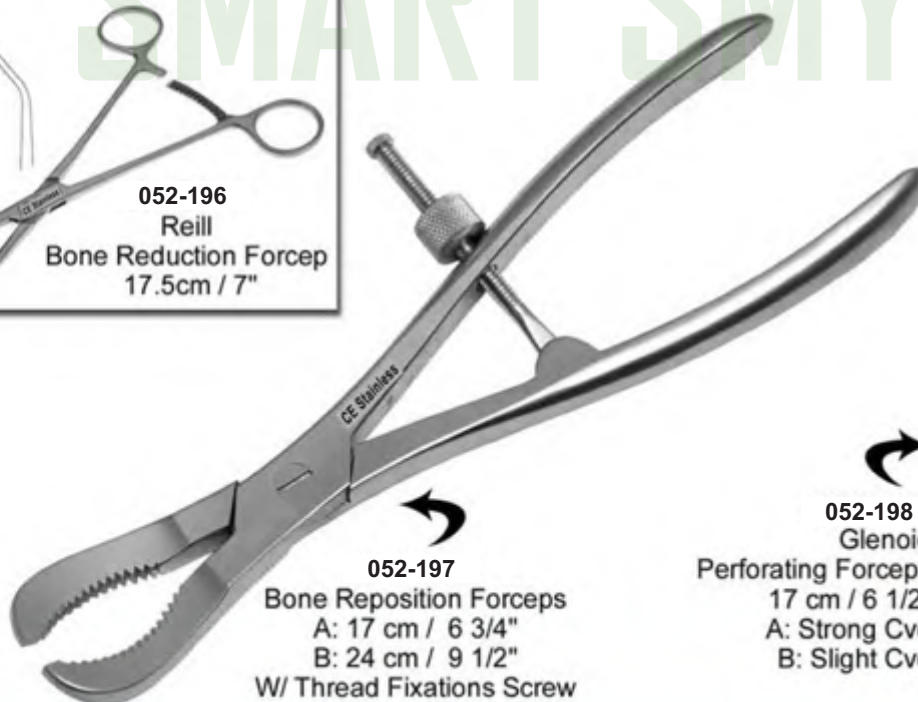

052-197
Bone Reposition Forceps
A: 17 cm / 6 3/4"
B: 24 cm / 9 1/2"
W/ Thread Fixations Screw

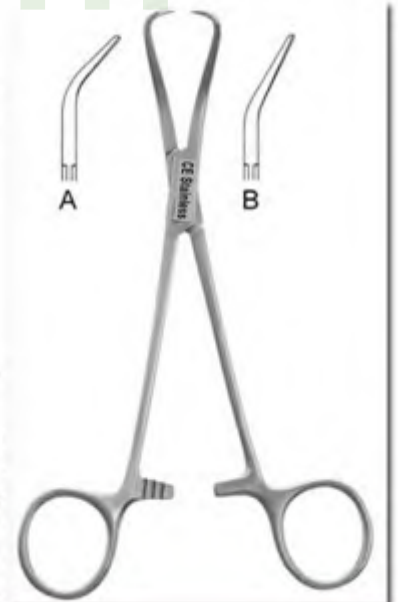

052-198
Glenoid
Perforating Forceps
17 cm / 6 1/2"
A: Strong Cvd
B: Slight Cvd

BONE CUTTING FORCEPS

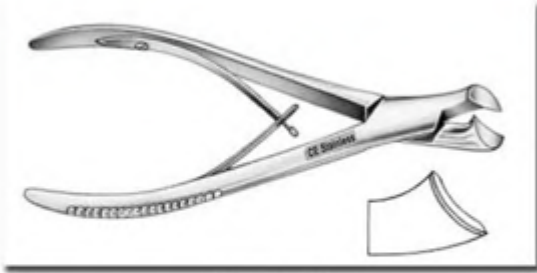

052-199
Marwalder Bone Nipper 18.5 cm / 7 1/4"



052-200
Cottle Kazanjian Bone Cutting Forceps
18.5 cm / 7 1/4"



052-201
Littauer Bone Cutting Forceps
15 cm / 6"
For small bones.



052-202
Liston Bone Cutting Forceps

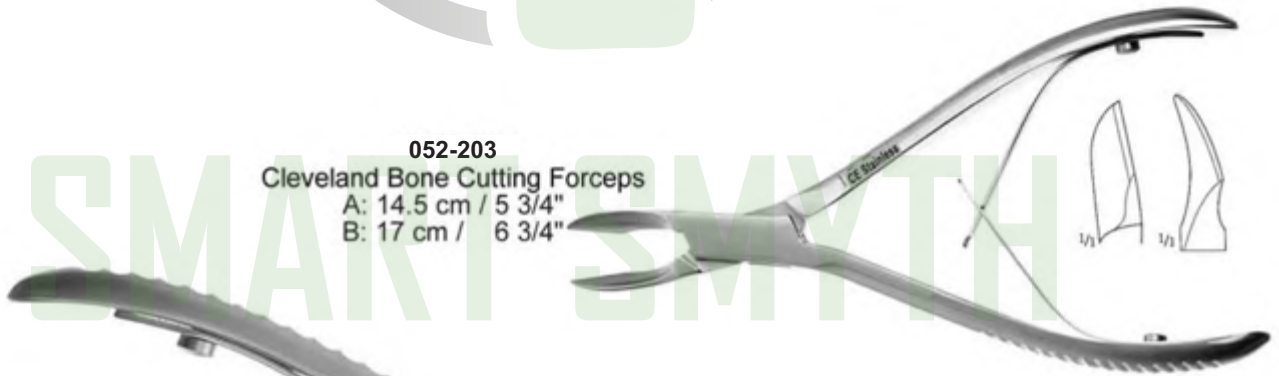
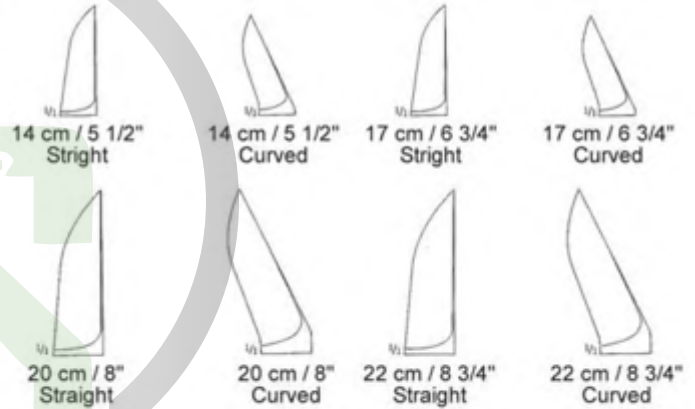

052-203
Cleveland Bone Cutting Forceps
A: 14.5 cm / 5 3/4"
B: 17 cm / 6 3/4"

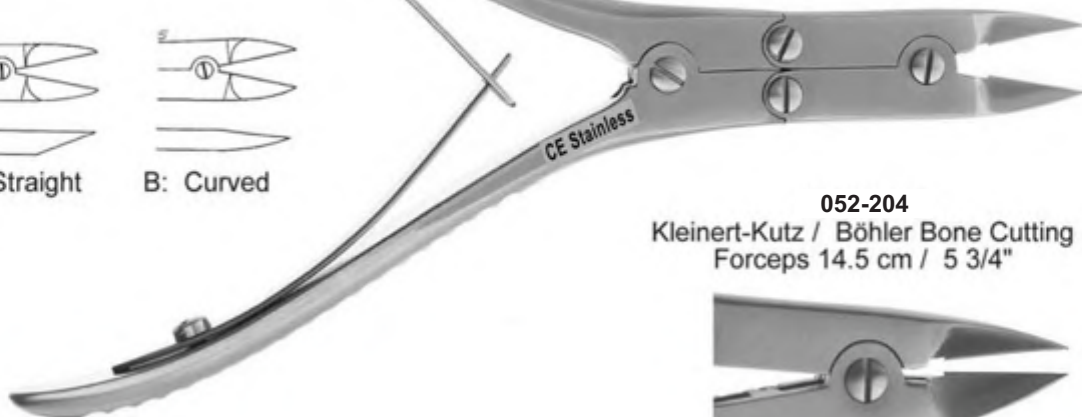
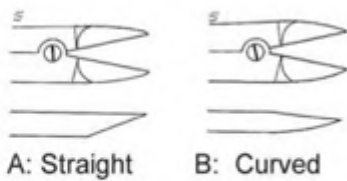

052-204
Kleinert-Kutz / Böhler Bone Cutting
Forceps 14.5 cm / 5 3/4"



BONE CUTTING FORCEPS



052-205
Mc Indoe
Bone Cutting Forceps
18 cm / 7"
Delicate Blades



052-206
Stille-Horsley / Liston Key
Bone Cutting Forceps
25.5 cm / 10"



45° Angled



90° Angled



Angled On Side

052-207
Semb
Bone Cutting Forceps
24.5 cm / 9 3/4"

BONE RONGEURS - NIBBLERS

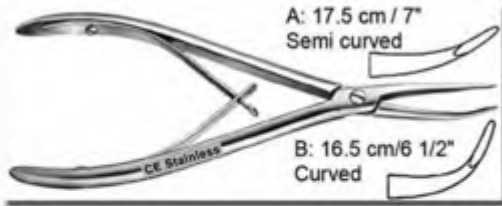

052-208 Stellbrink Bone Rongeur



052-209 A: 12.5 cm / 5"
B: 13.5 cm / 5 1/4"



052-210 13.5 cm / 5 1/4"

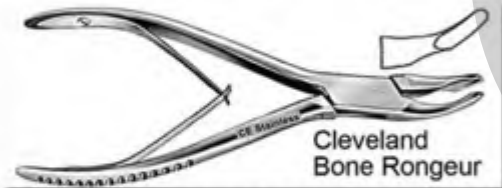

052-211
A: 13.5 cm / 5 1/4" B: 16.5 cm / 6 1/2"

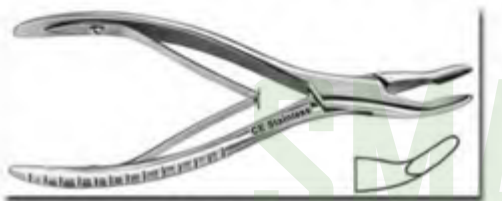

052-212 Mead Bone Rongeur
16.5 cm / 6 1/2"

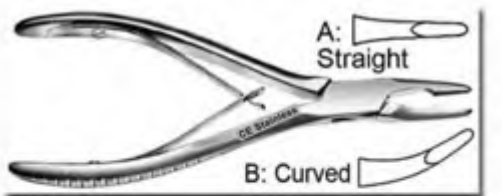

052-213 Jansen Bone Rongeur
18 cm / 7"

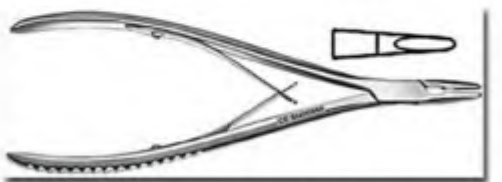

052-214 Lempert Bone Rongeur
19 cm / 7 1/2"



BONE RONGEURS - NIBBLERS



052-222 Böhler Bone Rongeur
15.5 cm / 6"



052-223 Beyer Bone Rongeur
18 cm / 7"



052-224 Zaufal-Jansen
Bone Rongeur 18 cm / 7"



052-225
Mayfield Bone Rongeur
18 cm / 7"



052-226 Marquard
Bone Rongeur 20.5 cm / 8"



052-227
Stille Bone Rongeur
22.5 cm / 8 3/4"

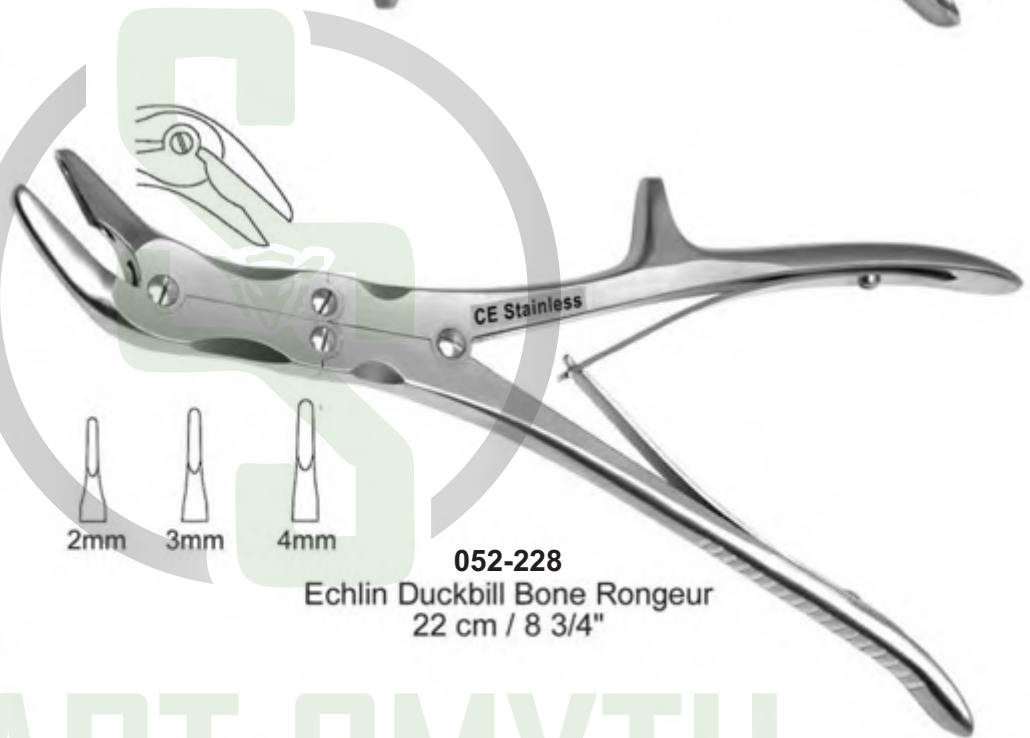

2mm 3mm 4mm

052-228
Echlin Duckbill Bone Rongeur
22 cm / 8 3/4"



052-229
Ruskin Bone Rongeur

← A: 18 cm / 7"

B: 24 cm / 9 1/2" →

BONE RONGEURS - NIBBLERS



052-230
Leksell Stille
Bone Rongeur
24 cm / 9 1/2"

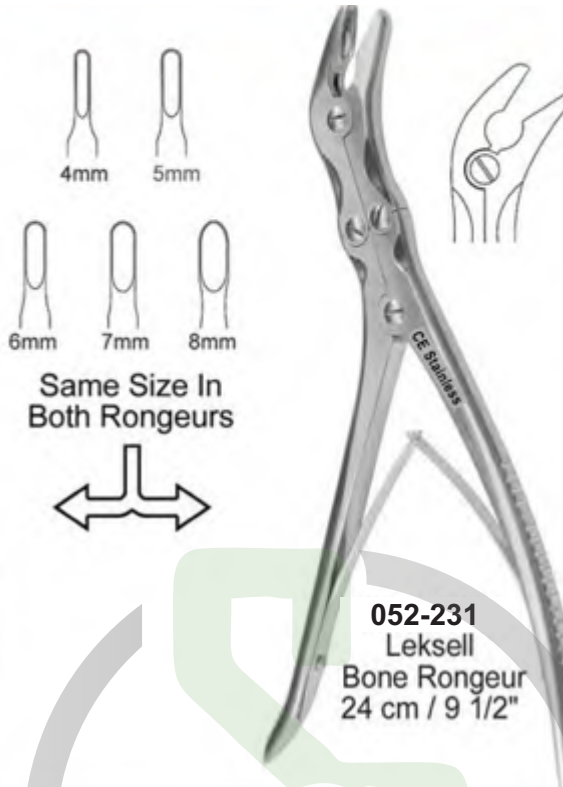

052-231
Leksell
Bone Rongeur
24 cm / 9 1/2"



052-232
Leksell Bone Rongeur
24 cm / 9 1/2"
4 / 5 / 6 / 7 / 8mm

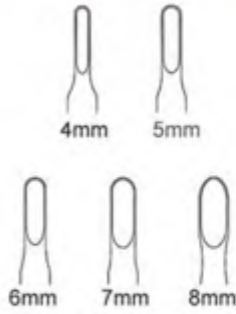

Same Size In
Both Rongeurs

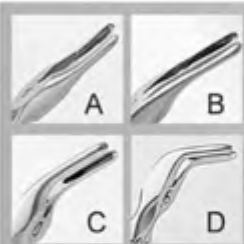

- A: Straight
- B: Slight Cvd
- C: Strong Cvd
- D: Extra Strong Cvd

3X16mm
Bite

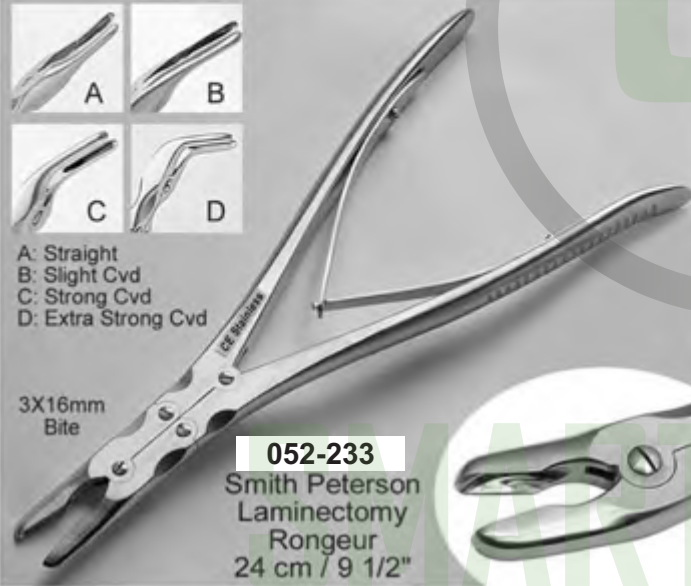

052-233
Smith Peterson
Laminectomy
Rongeur
24 cm / 9 1/2"



052-234
Leksell Bone Rongeur
23 cm / 9"

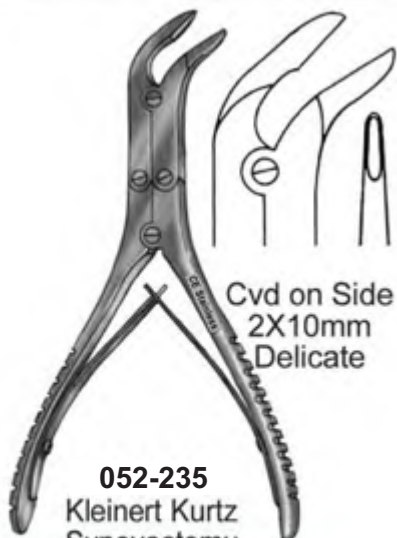

052-235
Kleinert Kurtz
Synovectomy
Rongeur
15 cm / 6"

Cvd on Side
2X10mm
Delicate

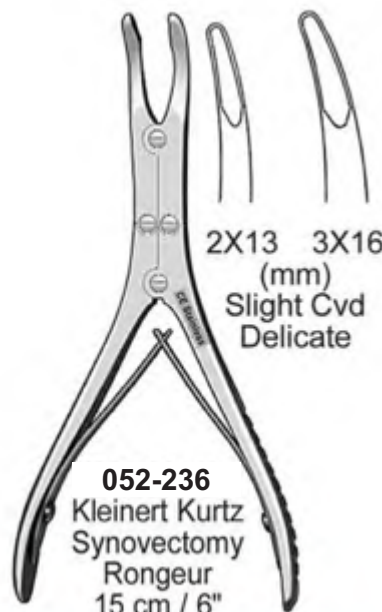

052-236
Kleinert Kurtz
Synovectomy
Rongeur
15 cm / 6"

2X13 3X16
(mm)
Slight Cvd
Delicate



052-237
Kleinert Kurtz
Synovectomy
Rongeur
15 cm / 6"

Full Cvd
3X8mm
Delicate

Tooth
Inside



052-238
Semb Bone Rongeur
23.5 cm / 9 1/4"

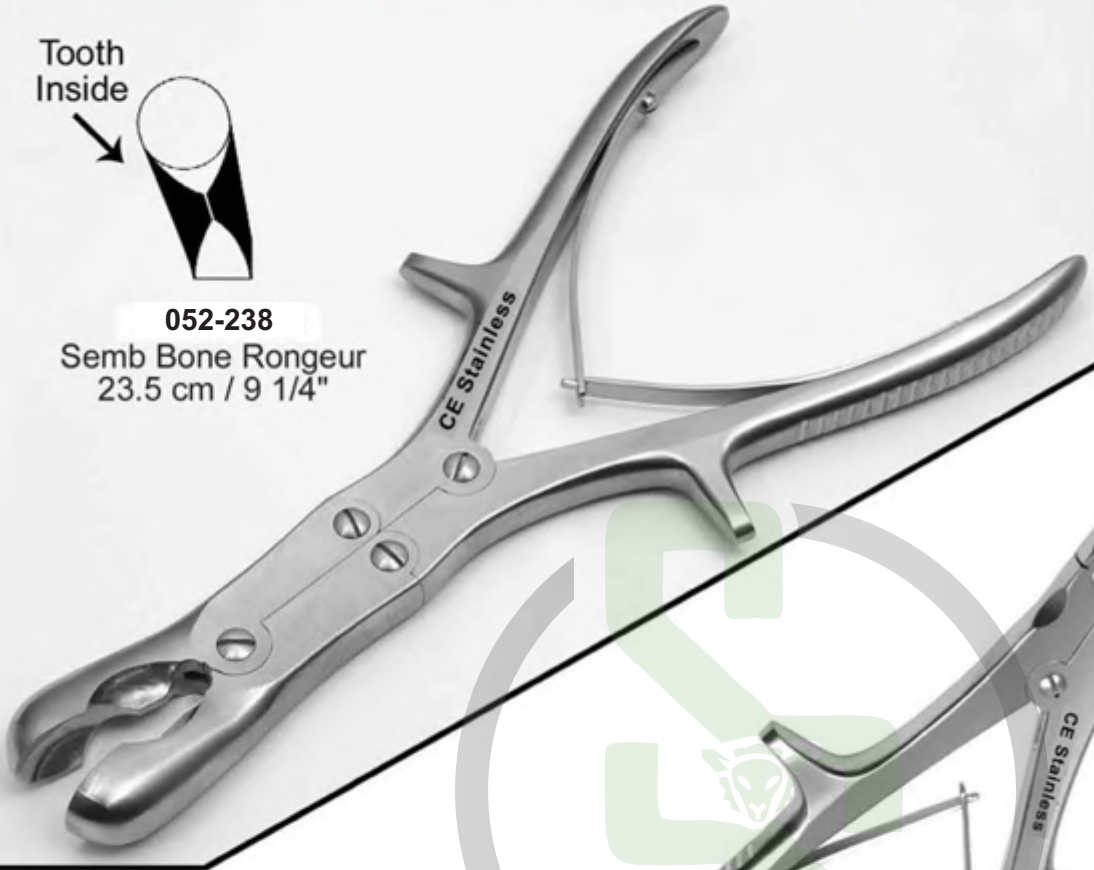

8mm

052-239
Stille Ruskin
Bone Rongeur
23.5 cm / 9 1/4"

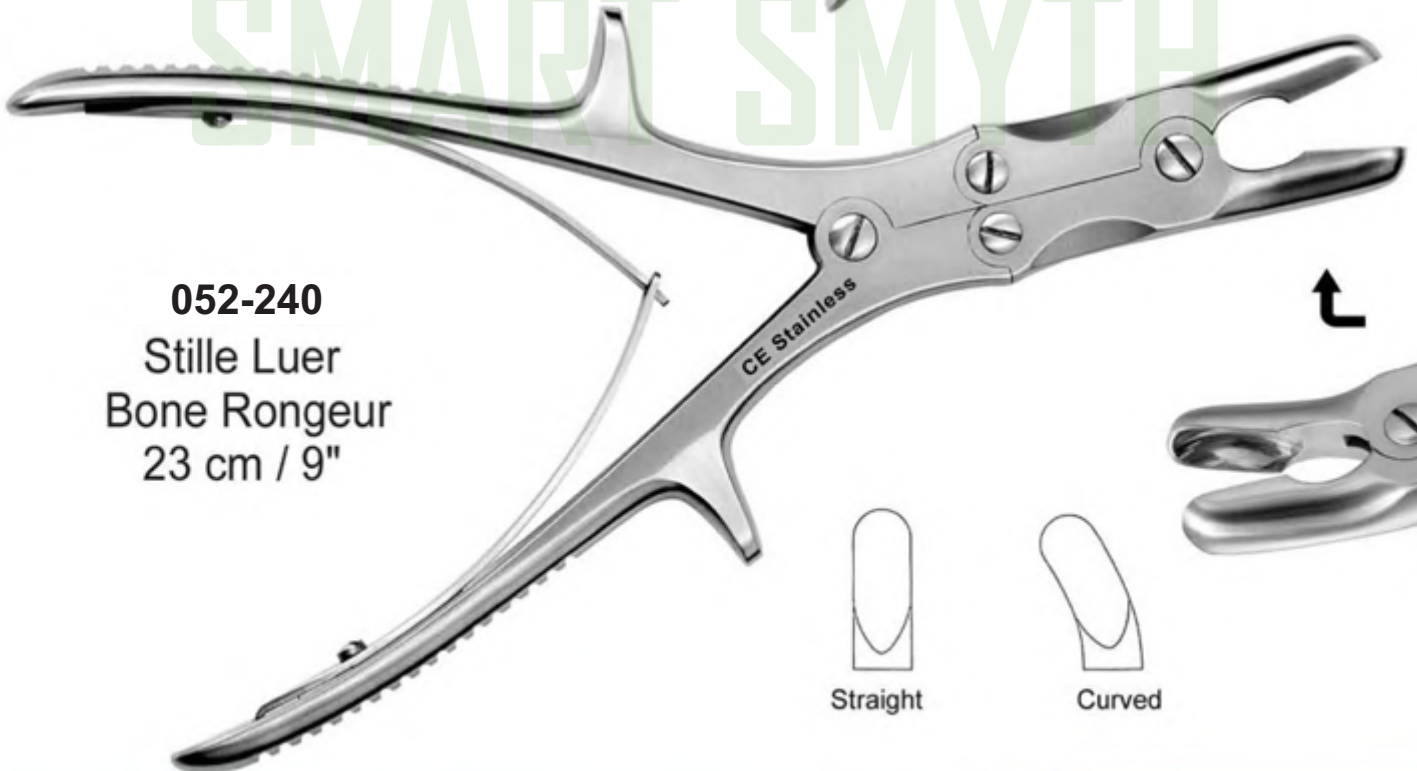

052-240
Stille Luer
Bone Rongeur
23 cm / 9"



Straight



Curved



BONE RONGEURS - NIBBLERS

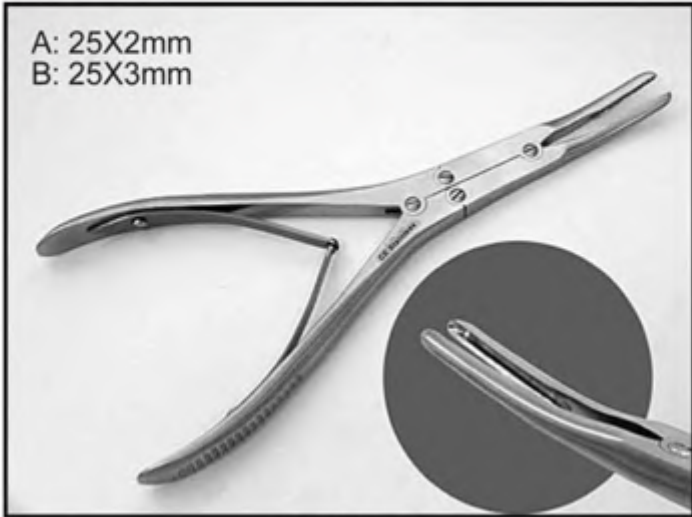

052-241
Mainz Long Neck Bone Rongeur 18 cm / 7"

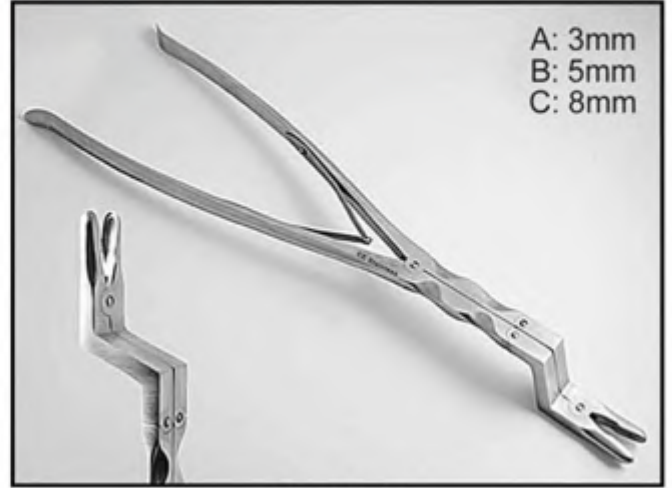

052-242
Leksell Bayonet Rongeur 41 cm / 16"

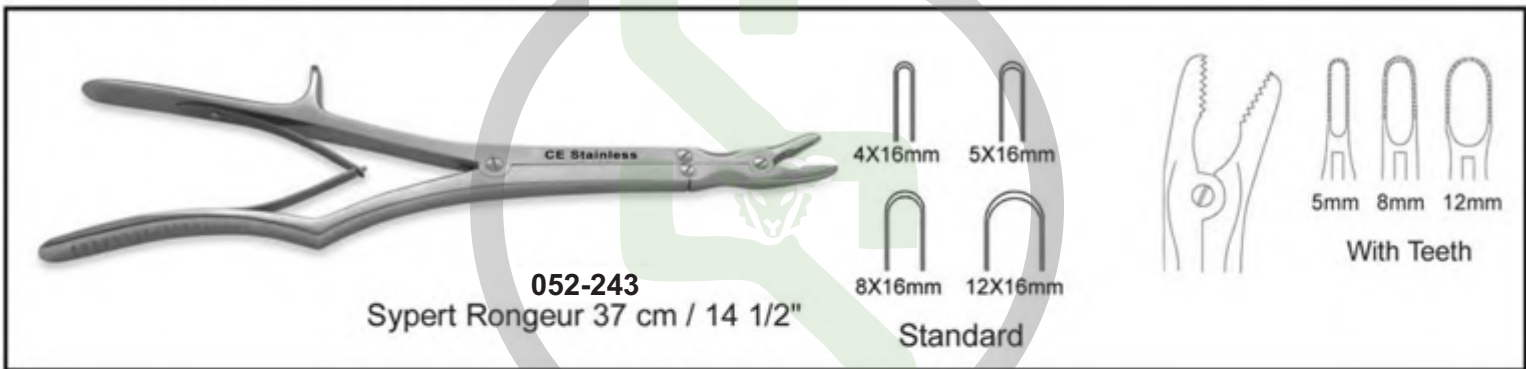

052-243
Sybert Rongeur 37 cm / 14 1/2"



052-244
Dale Thoracic Rongeur
37 cm / 14 1/2"

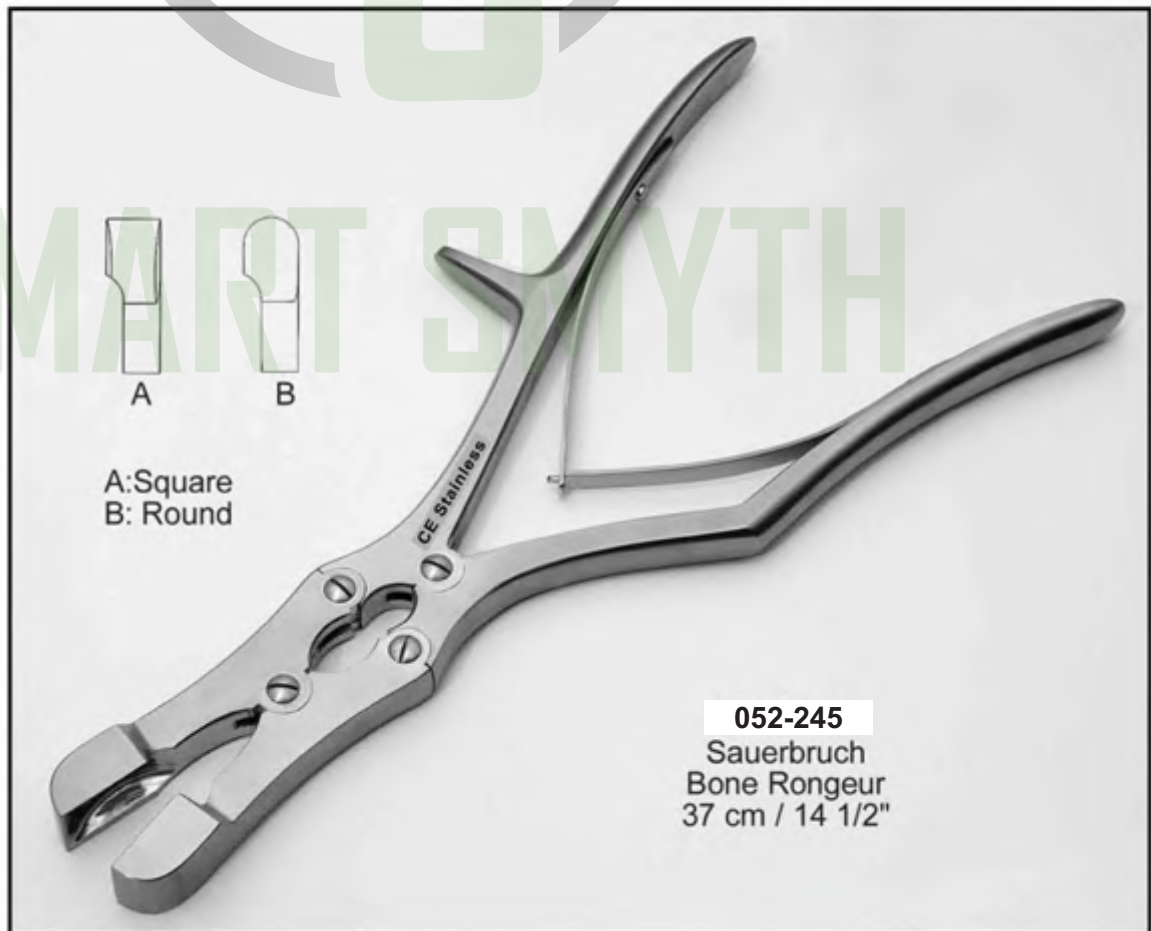

052-245
Sauerbruch Bone Rongeur
37 cm / 14 1/2"

RIB SHEARS



052-246
Rib Shear
Double Spring
22 cm / 8 3/4"



052-247
Rib Shear
Double Spring
A: 20 cm / 8"
B: 23 cm / 9"



052-248
Collin Rib Shear
17.5 cm / 7"



052-249
Collin Rib Shear
17 cm / 6 3/4"



052-250
Stille Rib Shear
21 cm / 8 1/4"



052-251
Gluck
Rib Shear
A: 16 cm / 6"
B: 18 cm / 7"
C: 20 cm / 8"
D: 23 cm / 9"

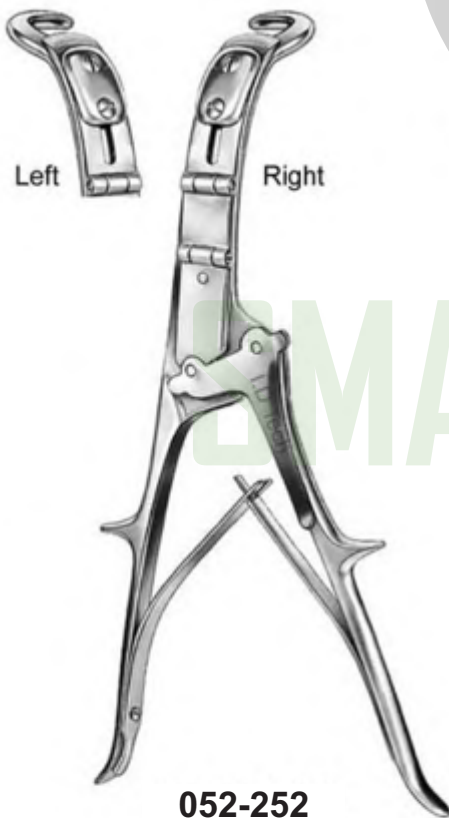

Left Right

052-252
Brunner
Rib Shear
28 cm / 11"



052-253
Giertz Stille
Rib Shear
25 cm / 10"



052-254
Sauerbruch
Rib Shear
A: 23 cm / 9"
A: 26 cm / 10 1/4"

RIB SHEARS - STERNUM CHISEL



052-255
Labsche
Rib Shear
25 cm / 10"



052-256
T Handle Labsche Sternum Chisel
24 cm / 9 1/2"



052-257
Rib Shear
Sideward
17 cm / 6 3/4"



052-258
Bethune Rib Shear
S Shaped Handle
34 cm / 13 1/2"



052-259
Bethune Rib Shear
S Shaped Handle
34 cm / 13 1/2"



052-260
Coryllos-Bethune Rib Shear
S Shaped Handle
35 cm / 13 3/2"

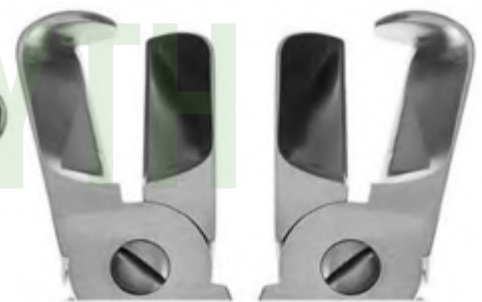

Left Right



052-261
Roos Rib Shear
Right Angled Jaw W/ Hook
33 cm / 13"

SPREADERS

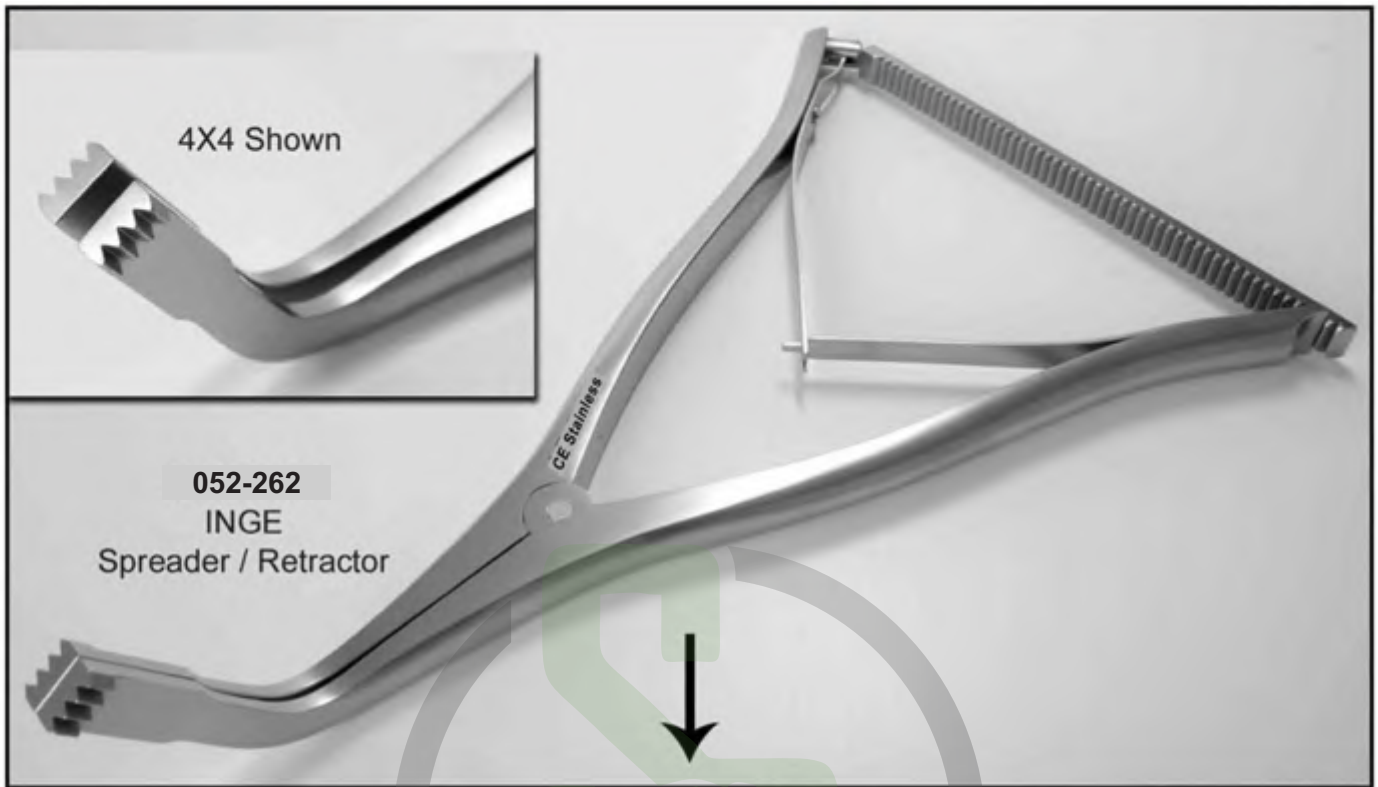

Available in 4X4 and 6X6 Teeth and Without Teeth (Plain)

<p>A: 4X4 Teeth B: Without Teeth 16.5 cm / 6 1/2"</p>	<p>C: 4X4 Teeth D: Without Teeth 25.5 cm / 10"</p>	<p>10 Inch Length Pattern</p>	<p>A: 6X6 Teeth B: Without Teeth 27 cm / 10 1/2" Flat Blades</p>	<p>C: 6X6 Teeth C: Without Teeth 27 cm / 10 1/2" Concave Blades</p>

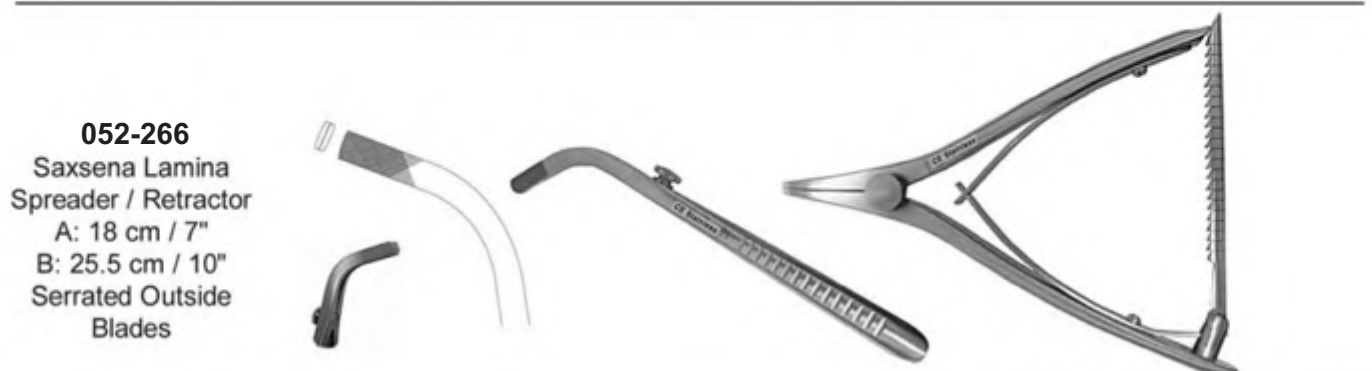

SPREADERS



052-267
Calcaneal Spreader
Smooth Pads 15X12mm
18 cm / 7"



052-268
Calcaneal Spreader
Grooved Pads 15X12mm
18 cm / 7"



052-269
Lombardi Femoral
Tibial Spreader (Small)
A: Grooved Pads 22X13mm
18 cm / 7"



B: Damond Cut Pads 22X13mm



B: Damond Cut Pads 22X13mm



052-270
Lombardi Femoral
Tibial Spreader (Large)
A: Grooved Pads 22X13mm
23.5 cm / 9 1/4"



052-271
Compressing Forceps
28 cm / 11"
Adjustable Locking
For Screws and Rods



052-272
Distracting Forceps
23 cm / 9"
Long Ratchet / Spiral Spring
For Screws and Rods



052-273
Distracting Forceps
25.5 cm / 10"
Leaf Spring
For Screws and Rods



052-274
Compression Forceps
28 cm / 11"
Leaf Spring / Long Ratchet
For Screws and Rods



052-275
Distractor
25.5 cm / 10"
Leaf Spring
For Screws and Rods

PLATE BENDERS

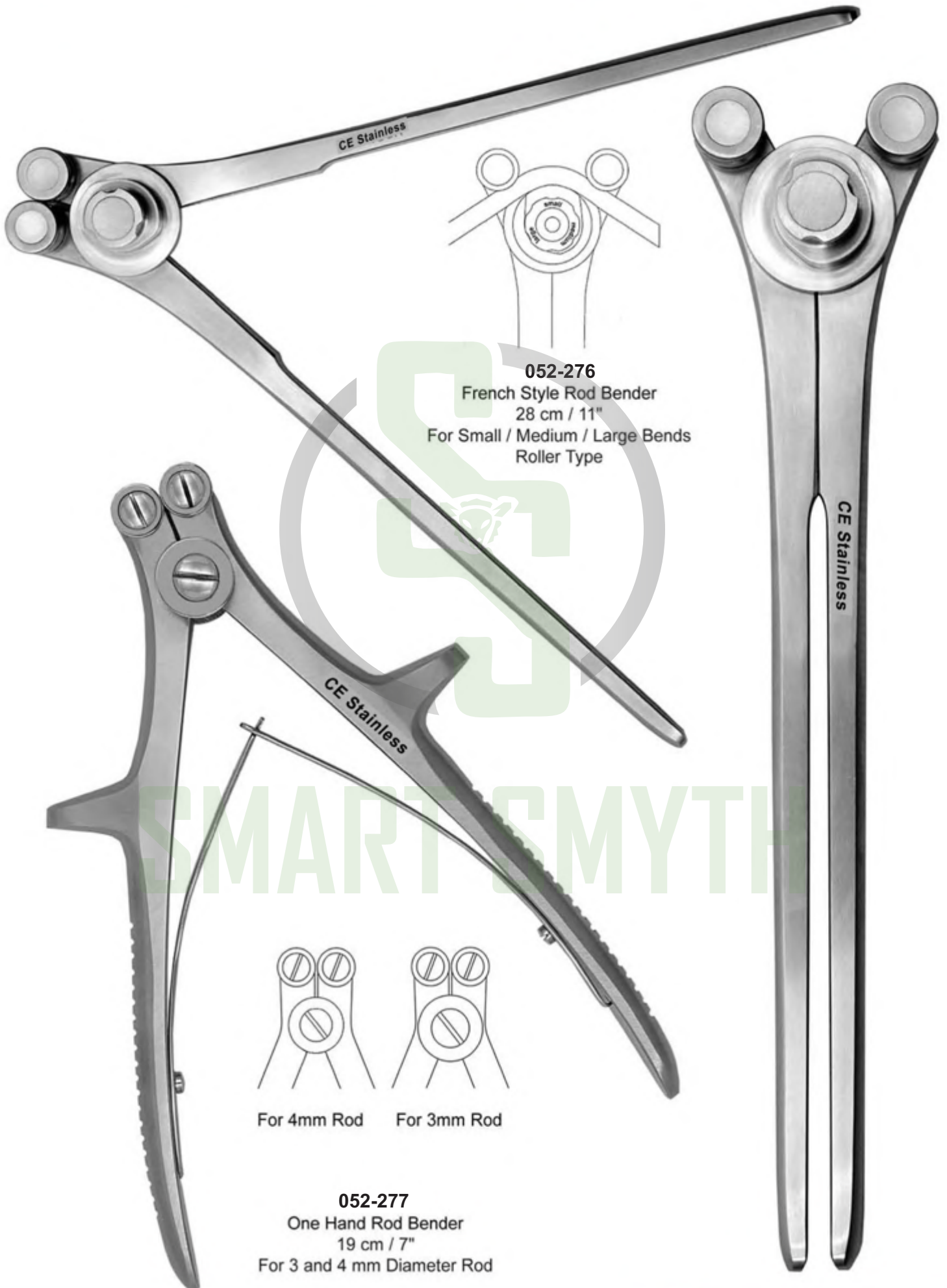

052-276

French Style Rod Bender

28 cm / 11"

For Small / Medium / Large Bends
Roller Type

CE Stainless

CE Stainless

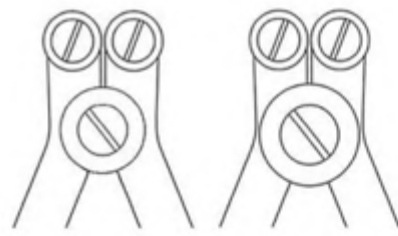

For 4mm Rod

For 3mm Rod

052-277

One Hand Rod Bender

19 cm / 7"

For 3 and 4 mm Diameter Rod

TC WIRE TWISTERS

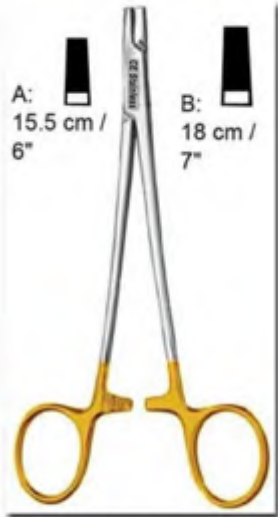

A: 15.5 cm / 6"
B: 18 cm / 7"

053-101 A / B
Wire Twisting
Forceps

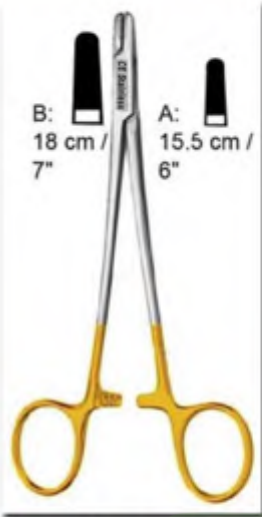

B: 18 cm / 7"
A: 15.5 cm / 6"

053-102 TC A / B
Wire Twisting
Forceps

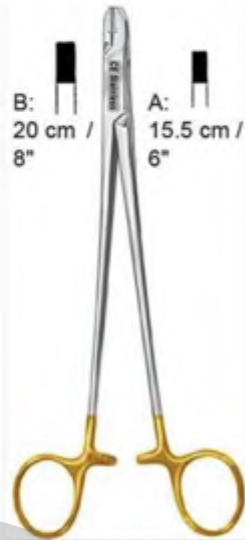

B: 20 cm / 8"
A: 15.5 cm / 6"

053-103 TC A / B
Wire Twisting
Forceps



053-104 TC Corwin
Combi-Wire Twisting
Forceps
18.5 cm / 7 1/4"



053-105 -TC
Wire Twisting Forceps
15.5 cm / 6"



053-106 -TC
Wire Twisting Forceps
16 cm / 6 1/4"



053-107 TC Wire Twisting
Forceps Heavy Pattern
19 cm / 7 1/2"

The Corwin-Hegar automatic Wire Twister is a special automatic twisting Instrument. In combination with a cerclage wire it can be used for fixation of fractures or temporal fixation. The Automatic Wire Twisters are available in different lengths and with various tungsten carbide inserts.



053-108 -TC Corwin-Hegar
Auto Wire Twisting Forceps
15 cm / 6"



CE Stainless

053-109 TC
Jet Wire Twisting Device
28 cm / 11" - 10mm Tip

TC SURGICAL SCISSORS

Scissors in this Section can also be manufactured without Carbide Tips / Gold Plating

053-111 TC

Mayo

Scissors TC Gold

- A: 14.5 cm / 5 3/4" Str or Cvd
- B: 17 cm / 6 3/4" Str or Cvd
- C: 23 cm / 9" Str or Cvd

Blunt / Blunt



053-112 TC

Operating (Standard)

Scissors TC Gold

- A: 13 cm / 5" Str or Cvd
- B: 14 cm / 5 1/2" Str or Cvd
- C: 15.5 cm / 6 1/2" Str or Cvd
- D: 18 cm / 7" Str or Cvd



Sharp / Sharp
Cvd or Str



Blunt / Blunt
Cvd or Str



Sharp / Blunt
Cvd or Str

Please Mention Above Styles When Ordering Standard TC Scissors

053-113 TC

Mayo Stille

Scissors TC Gold

- A: 14.5 cm / 5 3/4" Str or Cvd
- B: 17 cm / 6 3/4" Str or Cvd
- C: 23 cm / 9" Str or Cvd

Blunt / Blunt



053-114 TC

Metzenbaum

Scissors TC Gold

- A: 14 cm / 5 1/2" Str or Cvd
- B: 17 cm / 6 3/4" Str or Cvd
- C: 20 cm / 8" Str or Cvd
- D: 23 cm / 9" Str or Cvd

Blunt / Blunt



Blunt / Blunt

053-115 TC

Mayo-Harrington

Scissors TC Gold

- A: 20 cm / 8" Str or Cvd
- B: 23 cm / 9" Str or Cvd
- C: 28 cm / 11" Str or Cvd
- D: 30 cm / 12" Str or Cvd



053-116 TC

Ortho Universal Scissors TC Gold
12 cm / 4 1/3"

053-117 TC

Mayo-Nobel

Scissors TC Gold

- A: 16.5 cm / 6 1/2" Str or Cvd



TC WIRE & PIN CUTTERS

053-118 TC

Wire Cutting Plier TC Gold
A: 15 cm / 6" Cut Upto 1.3mm
B: 18 cm / 7" Cut Upto 1.6mm
C: 23 cm / 9" Cut Upto 2.5mm

Angled

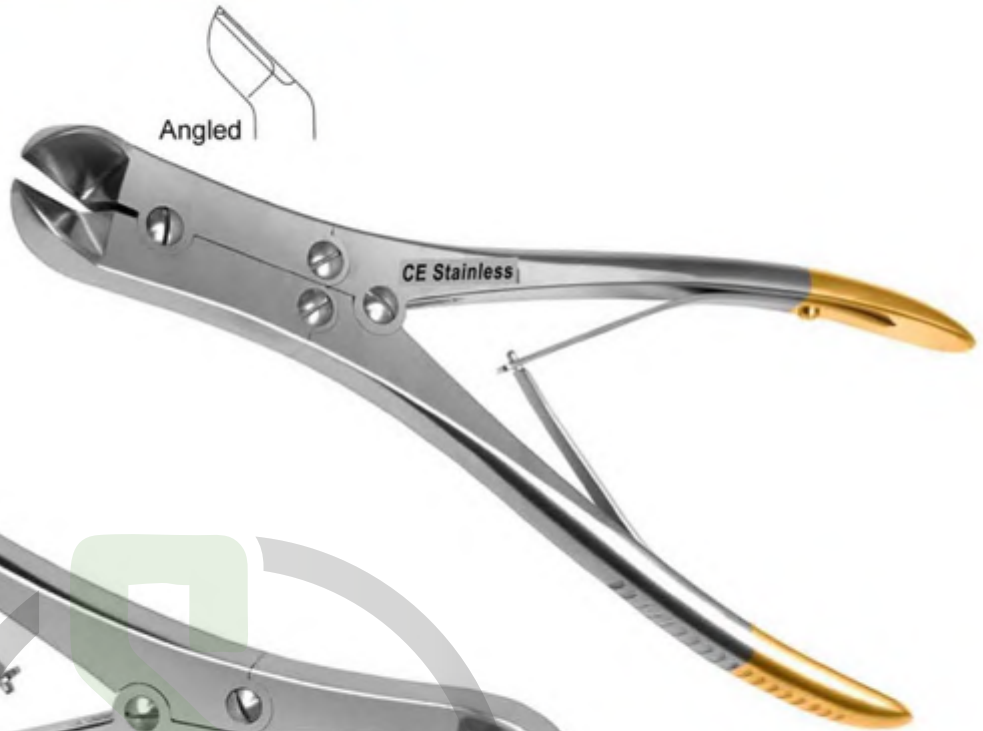

053-119 TC

Wire Cutting Plier TC Gold
A: 15 cm / 6" Cut Upto 1.3mm
B: 18 cm / 7" Cut Upto 1.6mm



053-120 TC

Wire Cutting Plier TC Gold
23 cm / 9" Cut Upto 2.5mm



053-121 TC

Wire Cutting Plier TC Gold
18 cm / 7" Cut Upto 1.6mm



TC WIRE & PIN CUTTERS

053-122 TC
Cannulated Pin Cutter TC Gold
18 cm / 7" Cut Upto 1.5mm



053-123 TC
Front End
Wire Cutting Plier
TC Gold
15 cm / 6"
Cut Upto 1.3mm



053-125 TC
Front End
Wire Cutting Plier
TC Gold
23 cm / 9"
Cut Upto 2.5mm



053-124 TC
Front End
Wire Cutting Plier
TC Gold
23 cm / 9"
Cut Upto 2.5mm



TC PIN & PLATES CUTTERS

053-126 TC
Plate / Pin Cutting Plier
TC Gold
23 cm / 9"
Cut Upto 3.0mm



053-127 TC
Pin / Wire Cutting Plier
TC Gold / Adjustable
23 cm / 9"
Cut Upto 2.5mm

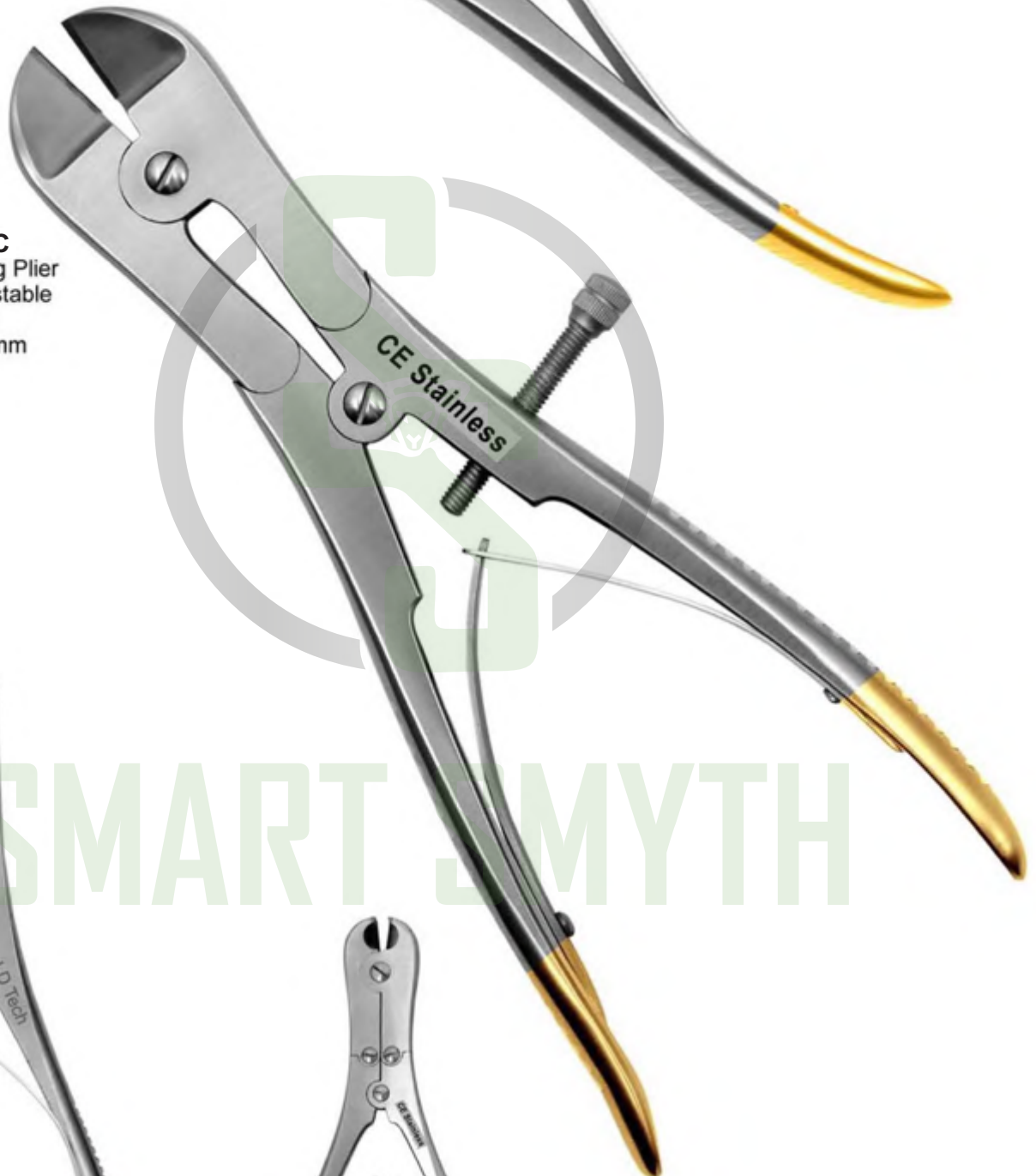

053-128 TC
Pin / Wire Cutting Plier
TC Gold
23 cm / 9"
Cut Upto 2.5mm



053-129 TC
Front / Side
Wire Cutting Plier
TC Gold
18 cm / 7"
Cut Upto 1.6mm

TC PIN CUTTERS HEAVY DUTY



053-130 TC
Heavy Duty
Pin Cutting Plier
TC Gold

- A: 30 cm / 12" Cut Upto 3mm
- B: 47 cm / 18 1/2" Cut Upto 5mm
- C: 56 cm / 22" Cut Upto 6mm
- D: 60 cm / 24" Cut Upto 7mm



053-131 TC
Heavy Duty
Pin End Cutting Plier
TC Gold

- A: 27 cm / 10 1/2" Cut Upto 3mm
- B: 38 cm / 15" Cut Upto 4mm

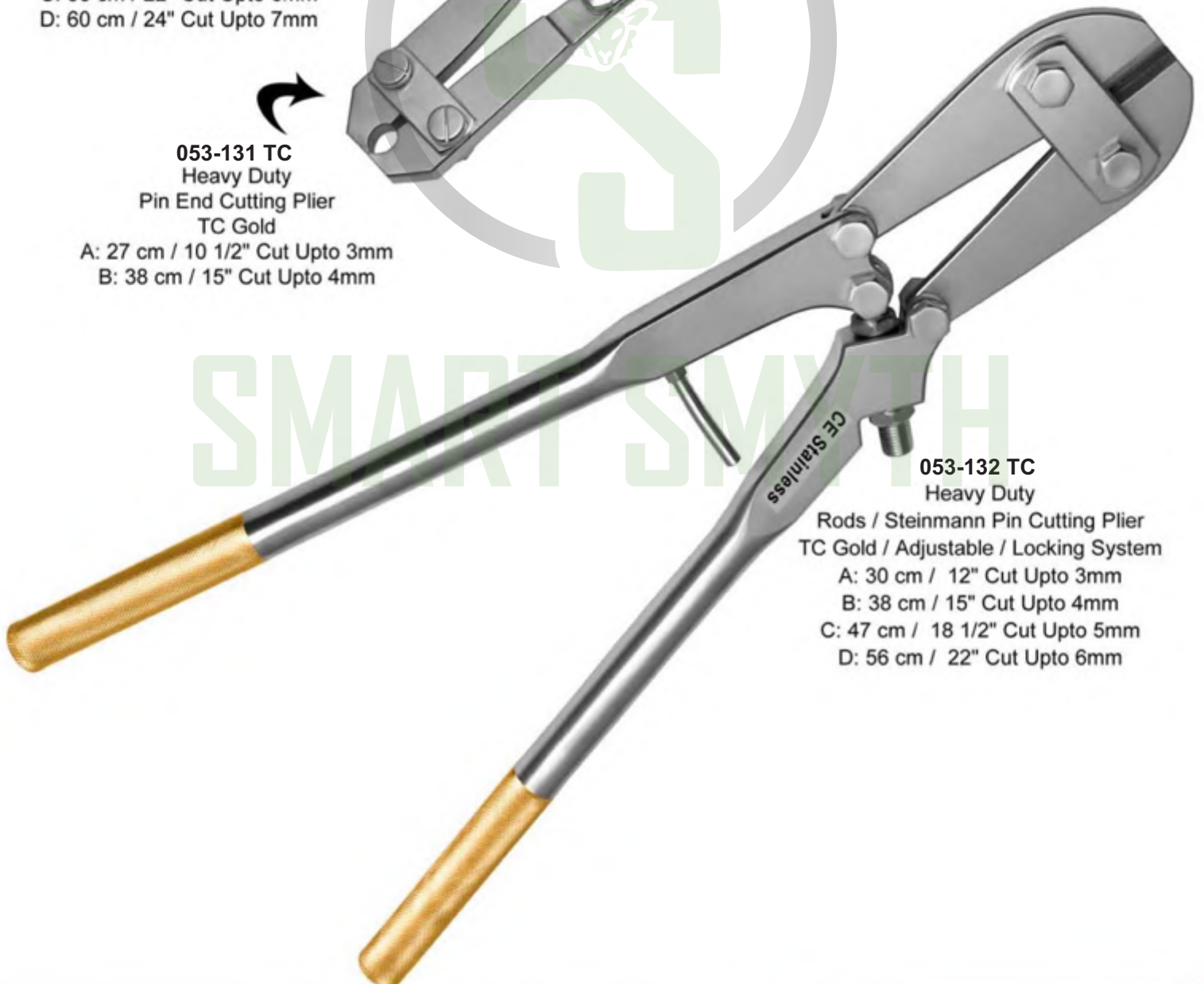

053-132 TC
Heavy Duty

- Rods / Steinmann Pin Cutting Plier
TC Gold / Adjustable / Locking System
- A: 30 cm / 12" Cut Upto 3mm
 - B: 38 cm / 15" Cut Upto 4mm
 - C: 47 cm / 18 1/2" Cut Upto 5mm
 - D: 56 cm / 22" Cut Upto 6mm

Drill Bits for Quick Coupling

Drill bit 1.1mm dia
for threaded hole for 1.5mm screws

Drill bit 1.5mm dia.
For threaded hole for 2.0mm screws and gliding hole for 1.5mm screws

Drill bit 2.0mm dia.
For threaded hole for 2.7 mm dia.
For gliding hole for 2.7mm screws

Item	Diameter	Total length	Usable length
054-101	1.1mm	060mm	035mm
054-102	1.5mm	085mm	060mm
054-103	1.5mm	110mm	085mm
054-104	2.0mm	100mm	145mm
054-105	2.0mm	125mm	100mm
054-106	2.7mm	100mm	075mm
054-107	2.7mm	125mm	100mm
054-108	2.7mm	100mm	075mm
054-109	2.0mm	125mm	100mm

Drill bit 2.5mm dia.
For threaded hole for 3.5 and 4.0mm screws

Drill bit 3.5mm
for gliding hole for 3.5mm screws

Item	Diameter	Total length	Usable length
054-110	2.5mm	110mm	085mm
054-111	2.5mm	180mm	155mm
054-112	3.5mm	100mm	085mm
054-113	3.5mm	195mm	170mm

Drill bit 3.2mm dia.
For threaded hole for 4.5 and 6.5mm screws

Drill bit 4mm dia.
For gliding hole for 4.5mm screws

Item	Diameter	Total length	Usable length
054-114	2.0mm	100mm	145mm
054-115	3.2mm	225mm	200mm
054-117	3.2mm	145mm	120mm
054-118	3.2mm	195mm	170mm
054-119	4.5mm	145mm	120mm
054-120	4.5mm	195mm	170mm

Drill Bits for Jacobs Type Chuck

Drill Bit for Jacobs chuck

Item	Diameter	Total length	Usable length
054-121	1.1mm	45mm	30mm
054-122	1.5mm	70mm	55mm
054-123	2.0mm	85mm	70mm
054-124	2.5mm	095mm	080mm
054-125	2.7mm	85mm	70mm
054-126	3.2mm	130mm	115mm
054-127	3.2mm	180mm	165mm
054-128	3.5mm	095mm	080mm
054-129	3.5mm	180mm	165mm
054-130	4.5mm	130mm	115mm
054-131	4.5mm	180mm	165mm

Tap for 2.0mm Cortex Screws
Predrilling: 1.5mm dia.

Item	Thread length	Total length
054-132	24mm	053mm
054-133	38mm	100mm

Tap for 2.7mm Cortex Screws
Predrilling: 2.0mm dia.

Item	Thread length	Total length
054-134	33mm	100mm
054-135	40mm	150mm

054-136
Tap for 2.7mm Cortex Screws
total length 125mm, thread length 40mm
predrilling: 2.0mm dia.

Predrilling: 3.2mm

Item	Length	Type
054-137	125mm	thread length 70mm
054-138	175mm	with length markings

Tap for 3.5mm Cortex Screws
Predrilling: 2.5mm dia.

Item	Total length	Type
054-139	175mm	with length markings
054-140	110mm	thread length 50mm

054-141
Tap for 3.5mm Cortex Screws
total length 110mm, thread length 50mm
predrilling: 2.5mm dia.

054-142
Tap for 4.5mm Cortex Screws
total length 125mm, thread length 70mm
predrilling: 3.2mm dia.

054-143

Tap for 1.5mm Cortex Screws
total length 50mm, thread length 20mm
predrilling: 1.1mm dia.

054-144

Tap for 6.5mm Cancellous Bone Screws
length 195mm, predrilling: 3.2mm dia.

Tap for 4.0mm Cancellous Bone Screws

Item	Total length	Usable length
054-145	110mm	085mm

054-146

Tap. Cannulated, for 7.0mm Cannulated Screws
length 230mm

054-147
Countersink Shaft 1.5/2.0
length 52mm, for mini quick coupling

054-155
Handle with quick coupling
length 110mm
for countersinks and
instruments for the removal of damaged screws

054-162
Screwdriver Shaft, hexagonal, small
length 100mm, for quick coupling
For 2.7 to 4.0mm screws.

054-168
Screwdriver Shaft, Hexagonal, large
length 100mm.
Final tightening of the screw has to
be done by hand.

054-148
Router, for Jacobs chuck
length 90mm

054-156
T-Handle with quick coupling
length 80mm, for taps

054-163
Screwdriver Shaft, hexagonal, with Holding Sleeve
for 1.5 and 2.0mm stainless steel screws
with hexagonal socket.

054-169
Screwdriver Shaft, cruciform, 1.5/2.0, with Holding Sleeve
length 50mm, for 1.5 and 2.0mm

054-149
Router, for quick coupling
length 90mm

054-157
Handle, small, with mini quick coupling

054-164
Screwdrivers, hexagonal, with T-Handle,
large to loosen tight screws.
A normal screwdriver can be
additionally inserted in the hollow
shaft of the T-handle.

054-170
Screwdriver, hexagonal, small with groove
length 200mm, for 2.7 to 4.0mm screws

054-150
Countersink, large
length 180mm, for 4.5mm cortex screws

054-158
Handle, medium, with mini quick coupling

054-165
Screwdriver with Universal Joint, large
length 290mm

054-171
Screwdriver, hexagonal, large, with groove
length 240mm

054-151
Countersink Shaft 3.5mm
length 72mm, for quick coupling,
to countersink the screw head

054-159
Handle, large, with mini quick coupling

054-166
Screwdriver, hexagonal, with Holding Sleeve,
length 165mm for 1.5 and 2.0mm stainless
steel screws with hexagonal socket.

054-172
Screwdriver, hexagonal, small, with Holding Sleeve
length 200mm

054-152
Countersink, cannulated, for 7.0mm Cannulated Screws
length 230mm

054-160
Allen Key, hexagonal, angled
for 4.5 to 7.0mm screws

054-167
Holding Sleeve

054-173
Holding Sleeve for no. 314.030
single, as spare

054-174
Holding Sleeve for Mini Screws
single

054-153
Handle with mini quick coupling

054-154
Hand Chuck for Kirschner Wires
length 145mm, Spannbereich 0.6 to 1.6mm dia.

054-161
Allen Key, hexagonal, small, angled
length 65mm, for 2.7 to 4.0mm screws



054-175
Insert Drill Sleeve 3.5/2.5
length 42mm, drill bit 2.5mm dia.



054-176
Insert Drill Sleeve 4.5/3.2
length 80mm
for long lag screws



054-177
Trocar 2.0mm dia.
Length 118mm, for percutaneous insertion of 7.0mm cannulated screws



054-178
Drill Sleeve 4.5/2.0
length 109mm, for percutaneous insertion of 7.0mm cannulated screws



054-179
Drill Sleeve 8.0/4.5
length 100mm, for percutaneous insertion of 7.0mm cannulated screws



054-180
Handle for Drill Guides
single



054-181
Drill Sleeve 3.0 with point
length 55mm



054-182
Handle for Drill Guides
for nos. 397.150 to 170.single



Item For diameter
054-183 1.5mm
054-174 2.0/2.7mm



054-184
Drill Sleeve 2.7



054-185
Double Drill Sleeve 1.5/1.01
for 1.5mm cortex screws
drill bits, 1.5 and 1.1mm dia



054-186
Double Drill Sleeve 2.0/1.5
for 2.0mm cortex screws



054-187
Double Drill Sleeve 2.7/2.0
for 2.7mm cortex screws

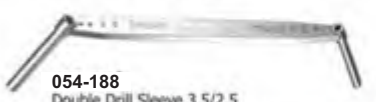

054-188
Double Drill Sleeve 3.5/2.5
for 3.5mm cortex screws and 4.0mm cancellous bone screws
drill bits 3.5 and 2.5 dia.,



054-189
Double Drill Sleeve 4.5/3.2
for 4.5mm cortex screws
drill bits: 4.5 and 3.2mm dia



054-190
Double Drill Sleeve 6.5/3.2
for 6.5mm cancellous bone screws
drill bit: 3.2mm dia.



054-191
Universal Drill Sleeve 2.7
Drill bits 2.0 and 2.7mm dia.,
Suitable for LC-DCP and round hole plates.



054-192
Universal Drill Guide 3.5
Drill bit 2.5 and 3.5mm dia., And tissue protection for taps nos. 311.310/320/340, Suitable for LC-DCP and round hole plates.



054-193
Universal Drill Guide 4.5/3.2
Drill bits 3.2 and 4.5mm dia.



054-194
DCP Drill Guide 2.0
for neutral and load position
drill bit 1.5mm dia.



054-195
DCP Drill Guide 2.7
for neutral and load position
drill bit 2.0mm dia.



054-196
DCP Drill Guide 3.5
for neutral an load position, drill bit 2.5m dia.



054-197
DCP Drill Guide 4.5
for neutral and load position, drill bit 3.2mm dia.



054-198
LC-DCP Drill Guide 3.5
for neutral an load position, drill bit 2.5mm dia.



054-199
LC-DCP Drill Guide 4.5
for neutral and load position, drill bit 3.2mm dia.



054-200
DCP Hip Drill Guide 4.5
for neutral and load position, for 4.5mm screws with DHS and angled blade plates, sleeve length 60mm, drill bit 3.2mm dia.



054-201
Triple Drill Sleeve 2.0
with 3 holes, opposite side 1 hole



054-202
DCP Mandible Drill Guide 2.7 short
drill bit 2.0mm dia



054-203
DCP Mandible Drill Guide 2.7 long
drill bit 2.0mm dia



054-204
Insert Drill Sleeve wit stop, for 4.5mm screws adjustable length to limit drilling depth, external dia. 4.5mm for drill bits of 3.2mm dia.



054-205
Parallel drill Guide 4.5
for percutaneous insertion of 7.0mm cannulated screws



054-206
Parallel Wire Guide 2.0mm dia.



054-207
Depth Gauge for 2.7 to 4.0m screws
measuring range up to 60mm



054-208
Depth Gauge for 2.7 to 4.0mm screws
measuring range up to 60mm



054-209
Depth Gauge for 4.5mm to 6.5mm screws
measuring range up to 110mm



054-213
Triple Drill Guide
130° angle, for 130° angled blade plates and for condylar plates,
drill bit 4.5mm dia.



054-214
Drill Guide with stop 3.5/2.7
to limit drilling depth



054-215
Protection Sleeve 11.0/8.0
for percutaneous insertion of 7.0mm cannulated screws



054-216
Holding Sleeve
length 80mm, for 2.7 to 4.0mm screws



054-217
Holding Sleeve for
lengt 80mm for 2.7mm screws and
3.5mm cannulated screws



054-218
Holding Sleeve, large, length 120mm
for Nos. 314.190/240/260/270/275



054-219
Screw Forceps, self-holding
length 85mm, to take screws out of the screw racks



Bending Iron for plates 2.7 and 3.5
Length 150mm, slid widths 2.5 and 4.5mm, required pairs
Item Slid placement
054-210 4.5/2.5mm
054-211 2.5/4.5mm



054-220
Drill Sleeve, pointed



Bending Iron for plates 1.5 and 2.0
Item Length Slid width
054-212 130mm 2.5mm



054-221
Bending Iron LC-DCP/DCP
length 250mm, for small and broad LC-DCP, DCP
slit widths 5 and 7mm, Required in pairs



054-222
Bending Iron for Kirschner Wires
length 120mm, for 1.25 to 2.5mm dia.



054-223
Bending Iron for Kirschner Wires
length 115mm, for 0.8 to 1.25mm dia.



054-224
Bending Iron for Reconstruction Plates 3.5 and 4.5
length 190mm, required in paris



054-225
Handle with Sleeve
wit rotating drill guide and anchoring point



054-226
Trocar Point, large, for number 397.110
for nos. 387.000/397.110



054-227
Cheek Retractor Ring, for number 397.110
for nos. 387.000/397.110



054-228
Combination Wrench 11mm
length 140mm



054-229
Pin Wrench
length 120mm, 4.5mm dia.
For tension device, distractor and knurled
nut of insertion handle for intramedullary nail



054-230
Socket Wrench 11mm
length 200mm



054-231
Slotted Hammer
length 270mm



054-232
Inserter/Extractor, with Adjustable Clamps
length 270mm, for the insertion and extraction of angled plates for
adults and hip plates for adolescents and children as well as tibial
plateau osteotomy plates.



054-233
Inserter/Extractor
length 175mm, for infant hip plate and mini hip plate.



054-234
ending Pliers for Reconstruction Plates 2.7 and 3.5
length 240mm



054-235
Bending Pliers for plate 2.4 to 4.0
length 230mm



054-236
Bending Pliers for plates

054-237
Anvil, narrow

054-238
Anvil, large

054-239
Bending Press
length 400mm



054-240
Cutter for thin plates 1.5 to 2.7
length 256mm



054-241
Bending Pliers
for reconstruction plates 2.7,
length 270mm, required in paris



054-242
Cerclage Wire Tightener
length 260mm
for twisting, for temporary fixation during reduction



054-243
Tension Device, articulated
Span 20mm, can also be used as a distractor.
Colour scale: yellow up to 500N, green up to 1000N,
red above 1000N.



054-244
Chisel Guide
with adjustable angle



054-245
Forceps with Sliding Blades
complete with two interchangeable blades
length 155mm, weight 42 g, speed lock

054-246
Blade with foot
single

054-247
Blade with tip
single



054-248
Measuring Device
fro drill bits, screws, Kirschner wires, and Steinmann pins



054-249
Holding Clip



054-250
Wire Passer
45mm bending diameter



054-251
Wire Passer
70mm bending diameter



054-252
Wire Tightener
length 240mm, with handle and two pegs



Cerclage Wire with eye
Packs of 10 Wires

Item	Diameter	Length
054-272	0.80mm	280mm
054-273	1.00mm	280mm
054-274	1.25mm	280mm
054-275	1.00mm	600mm
054-276	1.25mm	600mm
054-277	1.50mm	280mm
054-278	1.50mm	600mm

Cerclage Wires without eye
In precut lengths
packs of 10 wires

Item	Diameter	Length
291.220	0.40mm	150mm
291.240	0.60mm	175mm
291.260	0.80mm	200mm
291.270	1.00mm	250mm
291.280	1.25mm	300mm

054-279
Bone Wire Soft
Coil of 10 Meters
Implantable Material

Diameter Ø
A: 0.2 mm
B: 0.3 mm
C: 0.4 mm
D: 0.5 mm
E: 0.6 mm
F: 0.7 mm
G: 0.8 mm
H: 0.9 mm
I: 1.0 mm
J: 1.2 mm
K: 1.5 mm

Shanz Screws
Implantable Material

Length	Width	Height
2 x 60	15 mm	5 mm
3 x 60	15 mm	5 mm
3 x 80	15 mm	5 mm
3 x 80	20 mm	5 mm
3 x 100	15 mm	5 mm
3 x 120	15 mm	6 mm
4 x 80	20 mm	6 mm
4 x 100	20 mm	6 mm
4 x 120	20 mm	6 mm
4 x 140	20 mm	6 mm
5 x 120	30 mm	6 mm
5 x 140	30 mm	6 mm
5 x 150	30 mm	5 mm
5 x 160	40 mm	5 mm
5 x 180	40 mm	5 mm
5 x 200	40 mm	5 mm
5 x 220	40 mm	5 mm
6 x 120	40 mm	6 mm
6 x 140	40 mm	6 mm
6 x 150	40 mm	6 mm
6 x 160	40 mm	6 mm
6 x 180	40 mm	6 mm
6 x 200	40 mm	6 mm
6 x 220	40 mm	6 mm

Kirschner Wire
Implantable Material

Packs of 10 units	St. steel	Diameter	Length	Titanium Alloy
054-280	0.60mm	070mm	492.060	
054-281	0.80mm	070mm	492.080	
054-282	0.80mm	150mm	492.090	
054-283	1.00mm	150mm	492.100	
054-284	1.00mm	280mm	492.110	
054-285	1.25mm	150mm	492.120	
054-286	1.25mm	280mm	492.130	
054-287	1.40mm	150mm	492.140	
054-288	1.40mm	280mm	492.150	
054-289	1.60mm	150mm	492.160	
054-290	1.80mm	150mm	492.170	
054-291	1.60mm	280mm	492.180	

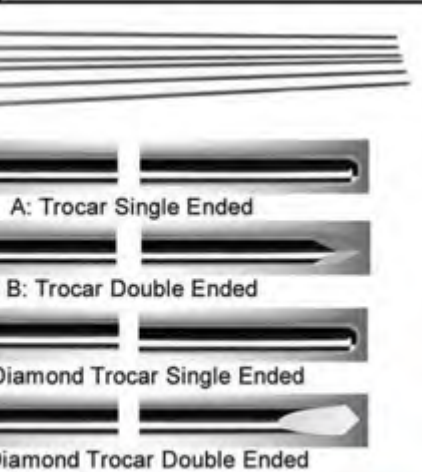

Kirschner Wire
Implantable Material

Packs of 10 units	St. steel	Diameter	Length	Titanium Alloy
054-292	1.80mm	280mm	492.190	
054-293	2.00mm	150mm	492.200	
054-294	2.00mm	280mm	492.210	
054-295	2.00mm	400mm	492.230	
054-296	2.50mm	150mm	492.250	
054-297	2.50mm	280mm	492.260	
054-298	2.50mm	400mm	492.280	
054-299	3.00mm	150mm	492.300	
054-300	3.00mm	280mm	492.310	
054-301	3.00mm	400mm	492.330	

Graphic Aluminum Instrument Box With
One Tray For 4.0mm Cannulated Cancellous Screw



IS.022	INSTRUMENT SET 4.0MM CANNULATED CANCELLOUS SCREWS	Units
	704.005 Threaded Guide Wire 1.25mm, 150mm	10
	704.008 Cannulated Counter Sink Q. C. dia. 6.0mm	1
	704.009 Cannulated Tap 4.0mm Q.C.	1
	704.010 Double Drill Sleeve 2.7/1.25mm	1
	704.011 Drill Guide with Stop 3.5mm/2.7mm with Two Inserts	1
	704.012 Cannulated Hexagonal Screw Driver - 2.5mm Tip	1
	704.013 Direct Measuring Device	1
	704.014 Stylet 1.25mm	1
	704.015 Holding Clip	1
	704.016 Cannulated Quick Coupling Tap Handle with Fibre Handle	1
	704.026 Cannulated Drill Bit 2.7mm/1.35mm, Length 160mm Q.C. End	1
	704.027 Cannulated Drill Bit 3.5mm/1.35mm, Length 160mm Q.C. End	1
	307.060 Drill & Tap Sleeve Combined 2.5/3.5mm	1
	400.088 Graphic Aluminum Instrument Box With One Tray For 4.0mm Cannulated Cancellous Screw	1

INSTRUMENTS FOR LARGE CANNULATED CANCELLOUS SCREW



IS.020	7.0MM LARGE CANNULATED CANCELLOUS INSTRUMENT SET	Units
	703.010 Cannulated Drill Bit 4.5m	1
	703.011 Cannulated Tap with T - Handle 7.0mm	1
	703.012 Protection Sleeve 4.5mm Dia	1
	703.013 Parallel Wire Guid	1
	703.014 Direct Measuring Devic	1
	703.015 Threaded Guide Wire 2.0mm Dia	5
	703.016 Large Cannulated Hexagonal Screw Driver 3.5mm Tip	1
	703.017 Stylet 2.0mm	1
	400.089 Graphic Aluminum Instrument Box With One Tray For 7.0mm Cannulated Cancellous Screw	1
IS.021	LARGE CANNULATED CANCELLOUS IMPLANT SET LARGE CANNULATED CANCELLOUS SCREWS 7.0MM DIA, 16MM THREAD	Units
	111.030 Length 30mm	3
	111.035 Length 35mm	3
	111.040 Length 40mm	3
	111.045 Length 45mm	3
	111.050 Length 50mm	3
	111.055 Length 55mm	3
	111.060 Length 60mm	3
	111.065 Length 65mm	3
	111.070 Length 70mm	3
	111.075 Length 75mm	3
	111.080 Length 80mm	3
	111.085 Length 85mm	3
	111.090 Length 90mm	3
	111.095 Length 95mm	3
	111.100 Length 100mm	3
	111.105 Length 105mm	2
	111.110 Length 110mm	2
	111.115 Length 115mm	2
	111.120 Length 120mm	2
7.0MM CANNULATED CANCELLOUS SCREWS, 32MM THREAD		
	112.030 Length 30mm	3
	112.035 Length 35mm	3
	112.040 Length 40mm	3

400.078

PFN / TFN Graphics Instruments Box Aluminium with Four Trays

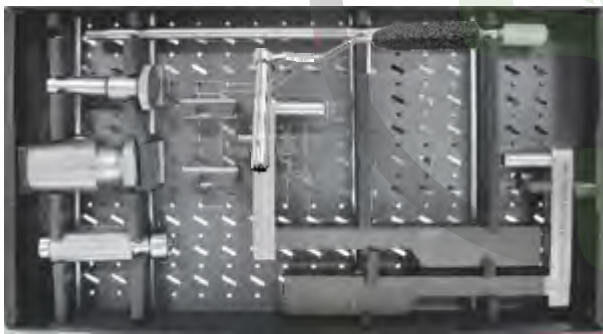

SMART SMYTH

Cat no.	Description	
IS.063	DELTA TFN / PFN INSTRUMENTS SET - Consisting of Following Items	Qty.
714.090	TFN / PFN JIG -130°	1
714.092	TFN / PFN JIG -135°	1
714.055	CONICAL BOLT	1
714.056	PROTECTION SLEEVE 12MM / 8MM	1
714.057	PROTECTION SLEEVE 8 MM / 6.4MM	1
714.058	DRILL SLEEVE 4.0MM FOR DISTAL HOLE	1
714.059	PFN / TFN GUIDE WIRE SLEEVE 2.5MM (FOR 8.0MM BOLT)	1
714.060	PFN / TFN GUIDE WIRE SLEEVE 2.0MM (FOR 6.4MM BOLT)	1
714.061	CANNULATED PROXIMAL REAMER 15MM	1
714.062	PROTECTION SLEEVE FOR CANNULATED PROXIMAL REAMER	1
714.063	REAMER FOR 8.0MM PFN / TFN BOLT	1
714.064	REAMER FOR 6.4MM PFN / TFN BOLT	1
714.065	PFN / TFN TAP 8.0MM DIA	1
714.066	PFN / TFN TAP 6.4MM DIA	1
714.067	SOCKET WRENCH 10MM	1
714.068	SUPING DRIVER	1
723.101	EXTRACTOR ROD	1
723.102	HANDLE FOR EXTRACTOR	1
723.103	HAMMER FOR EXTRACTOR ROD	1
714.072	T - HANDLE Q.C. FOR 6.4MM & 8.0MM TAPS	1
714.073	TOMY BAR	1
714.074	Trocar with T-Handle 12" Long for 6.4mm Sleeve	1
714.075	Trocar with T-Handle 12" Long for 8.0mm Sleeve	1
714.076	Graphic Measuring Scale	1
301.051	Extra Long Screw Driver 3.5mm Tip	1
303.070	Depth Gauge with 150mm Long Sleeve for TFN/PFN & AFN	1
261.640	DRILL BIT PLAIN SHANK 4.0MM DIA X 250MM LONG	1
384.010	DIAMOND POINTED AWL	1
710.003	REAMING ROD 3.0MM PLAIN FOR I.L. NAILS	1
710.004	REAMING ROD 3.0MM WITH STOPPER FOR I.L. NAILS	1
710.005	PLASTIC MEDULLARY TUBE	1
714.011	THREADED GUIDE WIRE 2.0MM X 450MM	1
714.012	THREADED GUIDE WIRE 2.5MM X 450MM	1
714.018	DIRECT MEASURING DEVICE S.S. LENGTH - 450MM	1
714.022	HEXAGONAL SCREW DRIVER CANNULATED FOR 6.4MM & 8.0MM BOLTS	1
400.078	PFN / TFN GRAPHICS INSTRUMENTS BOX ALUMINIUM WITH FOUR TRAYS	1



Cat No. IS.060	GRAPHIC INSTRUMENT SET FOR TITANIUM ELASTIC NAILS	Units
713.002	Insertor for Elastic Nail	1
713.004	Hammer Guide	1
713.006	Awl for Elastic Nail	1
713.008	Detachable Slide Hammer 400 gms.	1
713.010	F - Tool	1
713.012	Locking Plier for Elastic Nail	1
713.014	Pin Wrench	1
713.016	Beveled Tamp	1
713.018	Standard Tamp 2.5mm	1
713.020	Standard Tamp 3.0mm	1
713.022	Standard Tamp 3.5mm	1
713.024	Standard Tamp 4.0mm	1
307.070	Drill & Tap Sleeve Combined 3.2/4.5mm	1
368.030	Bone Hammer 500 gms.	1
260.270	Drill Bit S. S. Q. C. Dia 2.7mm x 125mm Length	1
260.325	Drill Bit S. S. Q. C. Dia 3.2mm x 200mm Length	1
260.475	Drill Bit S. S. Q. C. Dia 4.5mm x 200mm Length	1
Ti.009.144	Titanium Elastic Nail - 2.0mm Dia X 440mm Length	2
Ti.010.144	Titanium Elastic Nail - 2.5mm Dia X 440mm Length	2
Ti.011.144	Titanium Elastic Nail - 3.0mm Dia X 440mm Length	2
Ti.012.144	Titanium Elastic Nail - 3.5mm Dia X 440mm Length	2
Ti.013.144	Titanium Elastic Nail - 4.0mm Dia X 440mm Length	2
400.079	Graphic Aluminium Box with Two Tray	1



IS.017	DHS - DCS IMPLANT SET	Units
166.024	DHS Barrel Plate DCP Holes - 135 Deg. 4 Holes	2
166.025	DHS Barrel Plate DCP Holes - 135 Deg. 5 Holes	2
166.026	DHS Barrel Plate DCP Holes 135 Deg. 6 Holes	2
166.028	DHS Barrel Plate DCP Holes - 135 Deg. 8 Holes	1
166.030	DHS Barrel Plate DCP Holes - 135 Deg. 10 Holes	1
167.006	DCS Plate DCP Holes - 95 Deg. 6 Holes	1
167.008	DCS Plate DCP Holes - 95 Deg. 8 Holes	2
167.010	DCS Plate DCP Holes - 95 Deg. 10 Holes	2
167.012	DCS Plate DCP Holes - 95 Deg. 12 Holes	1
168.050	DHS/DCS Screw with Compression Screw-S.S. Length 50mm	1
168.055	DHS/DCS Screw with Compression Screw-S.S. Length 55mm	2
168.060	DHS/DCS Screw with Compression Screw-S.S. Length 60mm	2
168.065	DHS/DCS Screw with Compression Screw-S.S. Length 65mm	2
168.070	DHS/DCS Screw with Compression Screw -S.S.Length 70mm	1
168.075	DHS/DCS Screw with Compression Screw-S.S. Length 75mm	2
168.080	DHS/DCS Screw with Compression Screw-S.S. Length 80mm	2
168.085	DHS/DCS Screw with Compression Screw-S.S. Length 85mm	2
168.090	DHS/DCS Screw with Compression Screw-S.S. Length 90mm	2
168.095	DHS/DCS Screw with Compression Screw-S.S. Length 95mm	1
168.100	DHS/DCS Screw with Compression Screw-S.S. Length 100mm	1
400.040	DHS/DCS Implant Box with Three Trays for DHS/DCS Screws & Plates	1



CAT NO. IS.058	BIPOLAR INSTRUMENT SET	QTY.
386.040	Moore Hollow Chisel	1
386.062	Measuring Gauge For Prosthesis	1
386.070	Impactor - Nylon Faced	1
904.100	Rasp With Tomy Bar For Bipolar Prosthesis - Narrow Stem	1
904.101	Rasp With Tomy Bar For Bipolar Prosthesis - Standard Stem	1
904.105	Pencil Reamer - For Bipolar Prosthesis	1
904.106	Tapered Reamer - For Bipolar Prosthesis	1
904.107	Slotted Reamer - For Bipolar Prosthesis	1
904.119	Trial Cup For Dia.37mm	1
904.120	Trial Cup For Dia.39mm	1
904.121	Trial Cup For Dia.41mm	1
904.122	Trial Cup For Dia.43mm	1
904.123	Trial Cup For Dia.45mm	1
904.124	Trial Cup For Dia.47mm	1
904.125	Trial Cup For Dia.49mm	1
904.126	Trial Cup For Dia.51mm	1
904.127	Trial Cup For Dia.53mm	1
904.134	Holder / Pusher For Trial Cup	1
904.133	Impactor - Extractor For Bipolar Prosthesis	1
904.110	Bipolar Trial Stem - S.S. Standard Stem	1
904.111	Bipolar Trial Stem - S.S. Narrow Stem	1
713.008	Detachable Slide Hammer 400 Gms.	1
400.084	Graphic Aluminium Box for Bipolar Instrument Set with Two Trays	1



Cat No.		Units
IS.113	Large Fragment Instruments Set - Graphic Box	
210.033	Spanner - 11mm	1
260.450	Drill Bit - S.S. - Quick Coupling End Dia. 4.5mm X 130mm Long	1
260.320	Drill Bit - S.S. - Quick Coupling End Dia. 3.2mm X 130mm Long	3
263.040	Bone Tap with T - Handle Dia. 4.5mm Thread Length 70mm, Total Length 125mm	2
263.050	Bone Tap with T - Handle Dia. 6.5mm - Cancellous, Thread Length 32mm, Total Length 200mm	1
301.050	Large Hexagonal Screw Driver 3.5mm Tip	1
301.070	Screw Driver Shaft, Q.C. End 3.5mm Tip	1
302.020	Large Plate Bender - Pair	1
303.020	Large Depth Gauge	1
304.020	Large Neutral & Loaded Drill Guide	1
305.030	Counter Sink with T - Handle - 8.0mm Head (for 4.5, & 6.5mm Screws)	1
306.010	Quick Coupling Handle T-Type	1
307.095	Insert Drill Sleeve 3.2mm	1
307.070	Drill & Tap Sleeve Combined - 3.2/4.5mm	1
307.080	Drill & Tap Sleeve Combined - 3.2/6.5mm	1
308.000	Pointed Drill Guide with 4.5mm Tap Sleeve & 3.2mm Insert Drill Sleeve	1
371.000	Sharp Hook	1
400.107	Graphic Aluminium Box For Large Fragment Instruments	1

Cat No.	IS.013 Screw Set - Large	Units
107.060	Malleolar Screw 4.5mm Dia. Length 60mm	1
106.014	Cortical Screw 4.5mm Dia. 14 T.P.I. Length 14mm	2
106.016	Cortical Screw 4.5mm Dia. 14 T.P.I. Length 16mm	7
106.018	Cortical Screw 4.5mm Dia. 14 T.P.I. Length 18mm	7
106.020	Cortical Screw 4.5mm Dia. 14 T.P.I. Length 20mm	7
106.022	Cortical Screw 4.5mm Dia. 14 T.P.I. Length 22mm	7
106.024	Cortical Screw 4.5mm Dia. 14 T.P.I. Length 24mm	7
106.026	Cortical Screw 4.5mm Dia. 14 T.P.I. Length 26mm	1
106.028	Cortical Screw 4.5mm Dia. 14 T.P.I. Length 28mm	4
106.030	Cortical Screw 4.5mm Dia. 14 T.P.I. Length 30mm	1
106.032	Cortical Screw 4.5mm Dia. 14 T.P.I. Length 32mm	4
106.034	Cortical Screw 4.5mm Dia. 14 T.P.I. Length 34mm	1
106.036	Cortical Screw 4.5mm Dia. 14 T.P.I. Length 36mm	2
106.038	Cortical Screw 4.5mm Dia. 14 T.P.I. Length 38mm	1
106.040	Cortical Screw 4.5mm Dia. 14 T.P.I. Length 40mm	2
106.042	Cortical Screw 4.5mm Dia. 14 T.P.I. Length 42mm	1
106.044	Cortical Screw 4.5mm Dia. 14 T.P.I. Length 44mm	2
106.046	Cortical Screw 4.5mm Dia. 14 T.P.I. Length 46mm	1
106.048	Cortical Screw 4.5mm Dia. 14 T.P.I. Length 48mm	2
106.050	Cortical Screw 4.5mm Dia. 14 T.P.I. Length 50mm	6
108.025	Cancellous Screw 6.5mm Dia. 16mm Thread Length 25mm	6
108.030	Cancellous Screw 6.5mm Dia. 16mm Thread Length 30mm	6
108.035	Cancellous Screw 6.5mm Dia. 16mm Thread Length 35mm	6
108.040	Cancellous Screw 6.5mm Dia. 16mm Thread Length 40mm	6
108.045	Cancellous Screw 6.5mm Dia. 16mm Thread Length 45mm	2
108.050	Cancellous Screw 6.5mm Dia. 16mm Thread Length 50mm	2
108.055	Cancellous Screw 6.5mm Dia. 16mm Thread Length 55mm	2
108.060	Cancellous Screw 6.5mm Dia. 16mm Thread Length 60mm	2
115.025	Washer for 7.0mm Cannulated Cancellous Screw	2
400.020	Large Screw Box with Screw Tray & Screw Holding Forceps for 4.5 Cortical, 4.5 Malleolar & 6.5 Cancellous Screws	2
109.030	Cancellous Screw 6.5mm Dia. 32mm Thread Length 30mm	1
109.035	Cancellous Screw 6.5mm Dia. 32mm Thread Length 35mm	2
109.040	Cancellous Screw 6.5mm Dia. 32mm Thread Length 40mm	1
109.045	Cancellous Screw 6.5mm Dia. 32mm Thread Length 45mm	4
109.050	Cancellous Screw 6.5mm Dia. 32mm Thread Length 50mm	4
109.055	Cancellous Screw 6.5mm Dia. 32mm Thread Length 55mm	4
109.060	Cancellous Screw 6.5mm Dia. 32mm Thread Length 60mm	4
109.025	Cancellous Screw 6.5mm Dia. 32mm Thread Length 25mm	4
107.025	Malleolar Screw 4.5mm Dia. Length 25mm	4
107.030	Malleolar Screw 4.5mm Dia. Length 30mm	2
107.035	Malleolar Screw 4.5mm Dia. Length 35mm	2
107.040	Malleolar Screw 4.5mm Dia. Length 40mm	2
107.045	Malleolar Screw 4.5mm Dia. Length 45mm	2
107.050	Malleolar Screw 4.5mm Dia. Length 50mm	2
107.055	Malleolar Screw 4.5mm Dia. Length 55mm	2

PFNA - II Proximal Femoral Nail Antirotation INSTRUMENTS

400.092

Graphic Aluminium Box With Three Tray for PFNA Instruments Sets

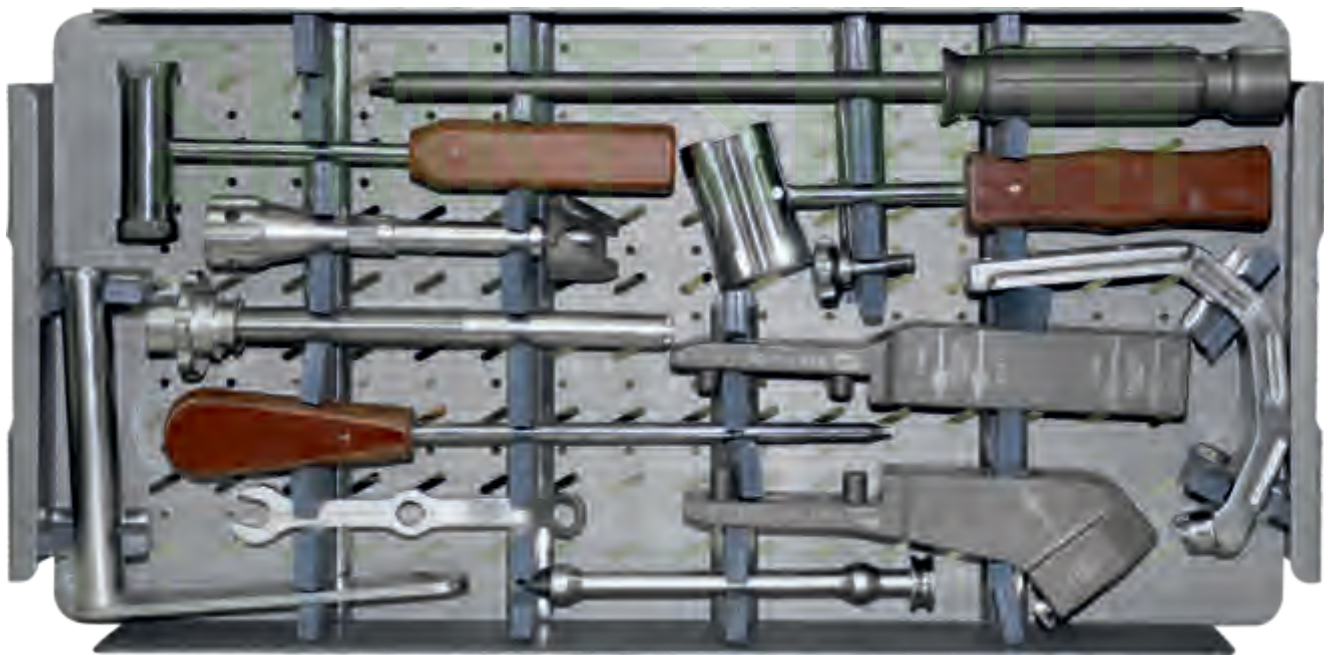
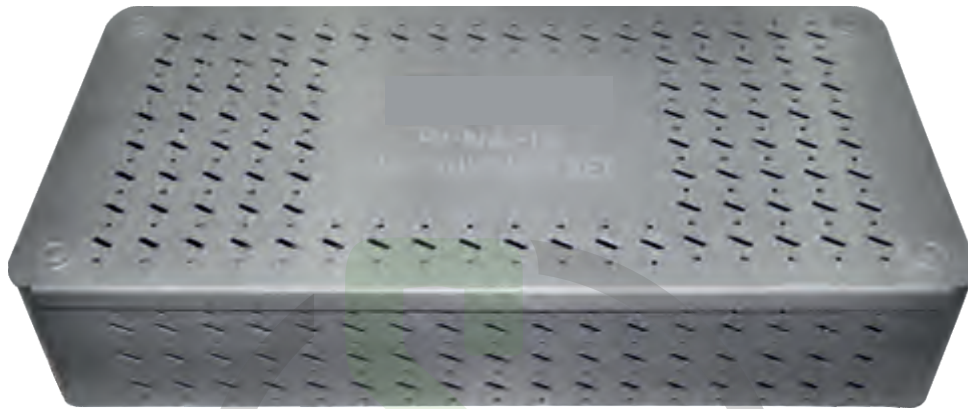

PFNA - II Proximal Femoral Nail Antirotation
PFNA - II Instrument Set

Cat No. IS.107	PFNA - II INSTRUMENT SET	Units
714.602	PFNA JIG - 130 DEG.	1
714.604	Attachment for PFNA Blade	1
714.606	Distal Hole Attachment	1
714.608	Locking Bolt for Attachment	1
714.610	Extractor for PFNA Blade	1
714.612	Extractor for PFNA Nail	1
714.614	8.0mm Ball Hex Screw Driver With T - Handle	1
714.616	Key For PFNA Blade	1
714.620	Threaded Protection Sleeve For PFNA 10.0mm Reamer & PFNA BLADE	1
714.622	Conical Bolt For PFNA	1
714.624	Guide Wire Sleeve For 2.5mm X 850mm Long Wire	1
714.626	Threaded Screw Driver for PFNA Blade	1
714.628	Threaded Guide Wire 3.0mm X 428mm Long	2
714.630	Protection Sleeve for Proximal Entry Reamer 16mm	1
714.634	Hammer Guide	1
714.636	Impacting Device for Hammer	1
714.560	Proximal Entry Reamer 16.0mm for PFNA	1
723.021	Cannulated Awl for Femur I.L. Nail	1
714.570	PFNA Reamer 10.0mm - Length 380mm	1
714.575	Guide Wire Sleeve for PFNA Blade Dia - 3.0mm	1
714.072	T - Handle Quick Coupling	1
303.070	Depth Gauge with 150mm Long Sleeve	1
713.008	Detachable Slide Hammer 400 gms.	1
368.010	Bone Hammer 200 gms	1
714.520	Trocar with T - Handle 11.0mm Dia	1
714.535	Protection Sleeve for 4.9mm Locking Bolt	1
710.005	Plastic Medullary Tube	1
261.641	Drill Bit Plain Shank 4.0mm X 300mm Long	1
714.540	Drill Sleeve for 4.0mm Drill Bit	1
714.545	Depth Gauge for PFNA	1
301.051	Extra Long Screw Driver 3.5mm Tip	1
723.039	Reaming Rod Plain 2.5mm X 850mm Length	1
400.092	Graphic Aluminum Box with Three Tray for PFNA Instruments Sets	1



IS.114	Small Fragment Instrument set- Graphic Box	Units
260.250	Drill Bit - S.S. - Quick Coupling End Dia. 2.5mm X 115mm Long	1
260.320	Drill Bit - S.S. - Quick Coupling End Dia. 3.2mm X 130mm Long	2
263.025	Bone Tap with T - Handle Dia. 3.5mm Thread Length 50mm, Total Length 125mm	2
263.030	Bone Tap with T - Handle Dia. 3.5mm - Cancellous, Thread Length 50mm, Total Length 125mm	2
301.040	Small Hexagonal Screw Driver 2.5mm Tip	2
301.060	Screw Driver Shaft, Q.C. End 2.5mm Tip	1
302.010	Small Plate Bender - Pair	1
303.010	Small Depth Gauge	1
304.010	Small Neutral & Loaded Drill Guide	1
305.020	Counter Sink with T - Handle - 6.0mm Head (for 2.7, 3.5 & 4.0 Screws)	1
306.010	Quick Coupling Handle T-Type	1
307.060	Drill & Tap Sleeve Combined - 2.5/3.5mm	1
307.090	Insert Drill Sleeve 2.5mm	1
322.030	K.Wire Bender	1
324.010	Plier Cum Wire Bender	1
341.010	Reduction forceps - Serrated Ratchet Lock - 140mm	1
342.010	Reduction Forceps - Pointed Ratchet Lock - 140mm	1
340.020	Self Centering Bone Holding Forceps 190mm	1
371.000	Sharp Hook	1
379.015	Hohmann Retractor 8mm Wide, Short Narrow Point, 160mm Length	2
379.020	Hohmann Retractor 15mm Wide, 160mm Length	2
381.008	Periosteal Elevator - Straight 8mm	1
400.108	Graphic Aluminium Box for Small Fragment Instruments	1

IS.012	SMALL FRAGMENT IMPLANT SET	
102.210	Cortical Screw 3.5mm Dia. - Self Tapping - 20 T.P.I. Legnth 10mm	4
102.212	Cortical Screw 3.5mm Dia. - Self Tapping - 20 T.P.I. Legnth 12mm	4
102.214	Cortical Screw 3.5mm Dia. - Self Tapping - 20 T.P.I. Legnth 14mm	8
102.216	Cortical Screw 3.5mm Dia. - Self Tapping - 20 T.P.I. Legnth 16mm	4
102.218	Cortical Screw 3.5mm Dia. - Self Tapping - 20 T.P.I. Legnth 18mm	8
102.220	Cortical Screw 3.5mm Dia. - Self Tapping - 20 T.P.I. Legnth 20mm	4
102.222	Cortical Screw 3.5mm Dia. - Self Tapping - 20 T.P.I. Legnth 22mm	4
102.224	Cortical Screw 3.5mm Dia. - Self Tapping - 20 T.P.I. Legnth 24mm	4
102.226	Cortical Screw 3.5mm Dia. - Self Tapping - 20 T.P.I. Legnth 26mm	4
102.228	Cortical Screw 3.5mm Dia. - Self Tapping - 20 T.P.I. Legnth 28mm	4
102.232	Cortical Screw 3.5mm Dia. - Self Tapping - 20 T.P.I. Legnth 32mm	4
102.236	Cortical Screw 3.5mm Dia. - Self Tapping - 20 T.P.I. Legnth 36mm	4
102.240	Cortical Screw 3.5mm Dia. - Self Tapping - 20 T.P.I. Legnth 40mm	4
103.012	Cancellous Screw 3.5mm Dia. - 14 T.P.I. Length 12mm	2
103.014	Cancellous Screw 3.5mm Dia. - 14 T.P.I. Length 14mm	2
103.016	Cancellous Screw 3.5mm Dia. - 14 T.P.I. Length 16mm	2
103.018	Cancellous Screw 3.5mm Dia. - 14 T.P.I. Length 18mm	2
103.020	Cancellous Screw 3.5mm Dia. - 14 T.P.I. Length 20mm	2
103.022	Cancellous Screw 3.5mm Dia. - 14 T.P.I. Length 22mm	2
103.024	Cancellous Screw 3.5mm Dia. - 14 T.P.I. Length 24mm	2
103.028	Cancellous Screw 3.5mm Dia. - 14 T.P.I. Length 28mm	2
103.030	Cancellous Screw 3.5mm Dia. - 14 T.P.I. Length 30mm	2
103.035	Cancellous Screw 3.5mm Dia. - 14 T.P.I. Length 35mm	2
103.040	Cancellous Screw 3.5mm Dia. - 14 T.P.I. Length 40mm	2
103.045	Cancellous Screw 3.5mm Dia. - 14 T.P.I. Length 45mm	2
103.050	Cancellous Screw 3.5mm Dia. - 14 T.P.I. Length 50mm	2
103.055	Cancellous Screw 3.5mm Dia. - 14 T.P.I. Length 55mm	2
103.060	Cancellous Screw 3.5mm Dia. - 14 T.P.I. Length 60mm	2
115.010	Washer for 4.0mm Cancellous Screw	6
139.123	One Third Tubular Plate with Collar 3 Holes	1
139.124	One Third Tubular Plate with Collar 4 Holes	2
139.125	One Third Tubular Plate with Collar 5 Holes	2
139.126	One Third Tubular Plate with Collar 6 Holes	2
139.127	One Third Tubular Plate with Collar 7 Holes	1
139.128	One Third Tubular Plate with Collar 8 Holes	1
104.012	Cancellous Screw 4.0mm Dia. Short - Thread Length 12mm	2
104.014	Cancellous Screw 4.0mm Dia. Short - Thread Length 14mm	2
104.016	Cancellous Screw 4.0mm Dia. Short - Thread Length 16mm	2
104.018	Cancellous Screw 4.0mm Dia. Short - Thread Length 18mm	2
104.020	Cancellous Screw 4.0mm Dia. Short - Thread Length 20mm	2
104.022	Cancellous Screw 4.0mm Dia. Short - Thread Length 22mm	2
104.024	Cancellous Screw 4.0mm Dia. Short - Thread Length 24mm	2
104.028	Cancellous Screw 4.0mm Dia. Short - Thread Length 28mm	2
104.030	Cancellous Screw 4.0mm Dia. Short - Thread Length 30mm	2
104.035	Cancellous Screw 4.0mm Dia. Short - Thread Length 35mm	2
104.040	Cancellous Screw 4.0mm Dia. Short - Thread Length 40mm	2
104.045	Cancellous Screw 4.0mm Dia. Short - Thread Length 45mm	2
104.050	Cancellous Screw 4.0mm Dia. Short - Thread Length 50mm	2
104.055	Cancellous Screw 4.0mm Dia. Short - Thread Length 55mm	2
104.060	Cancellous Screw 4.0mm Dia. Short - Thread Length 60mm	2
140.105	3.5mm DCP Plate (3.5mm Thickness) 5 Holes	1
140.106	3.5mm DCP Plate (3.5mm Thickness) 6 Holes	2
140.107	3.5mm DCP Plate (3.5mm Thickness) 7 Holes	2
140.108	3.5mm DCP Plate (3.5mm Thickness) 8 Holes	1
140.110	3.5mm DCP Plate (3.5mm Thickness) 10 Holes	1
141.103	Small T - Plate Right Angled - Head 3 Holes, 3 Holes	1
141.104	Small T - Plate Right Angled - Head 3 Holes, 4 Holes	1
142.103	Small T - Plate Oblique Angled for Right & Left Radius 3 Holes	1
142.104	Small T - Plate Oblique Angled for Right & Left Radius 4 Holes	1
185.116	Kirschner Wire with Trocar Tip Dia. 1.0mm, Length 150mm	10
185.140	Kirschner Wire with Trocar Tip Dia. 1.5mm, Length 150mm	10
185.156	Kirschner Wire with Trocar Tip Dia. 2.0mm, Length 150mm	10
400.010	Small Fragment Instrument Box with Two Trays for Instruments & One Tray for Screws with Screw Holding Forceps	1

IS.104

Instruments Set for Spine





SMART SMYTH



Orthopedic

IMPLANTS & INSTRUMENTS

Spine INSTRUMENTS

